

Inspiron 17

7000 Series

Owner's Manual

Computer model: Inspiron 7737

Regulatory model: P24E

Regulatory type: P24E001



Notes, Cautions, and Warnings



NOTE: A NOTE indicates important information that helps you make better use of your computer.



CAUTION: A CAUTION indicates potential damage to hardware or loss of data if instructions are not followed.



WARNING: A WARNING indicates a potential for property damage, personal injury, or death.

© 2013 Dell Inc.

Trademarks used in this text: Dell™, the DELL logo, and Inspiron™ are trademarks of Dell Inc.; Microsoft® and Windows® are either trademarks or registered trademarks of Microsoft Corporation in the United States and/or other countries; Bluetooth® is a registered trademark owned by Bluetooth SIG, Inc. and is used by Dell under license.

Contents

Before Working Inside Your Computer	7
Before You Begin	7
Recommended Tools.	7
Safety Instructions.	8
After Working Inside Your Computer	9
Removing the Battery	10
Procedure	10
Replacing the Battery	12
Procedure	12
Removing the Memory Module(s)	13
Prerequisites.	13
Procedure	13
Replacing the Memory Module(s)	15
Procedure	15
Postrequisites.	15
Removing the Optical Drive	16
Prerequisites.	16
Procedure	16
Replacing the Optical Drive	18
Procedure	18
Postrequisites.	18
Removing the Hard Drive	19
Prerequisites.	19
Procedure	19
Replacing the Hard Drive	21
Procedure	21
Postrequisites.	21

Removing the Keyboard	22
Prerequisites.	22
Procedure	22
Replacing the Keyboard	26
Procedure	26
Postrequisites.	26
Removing the Base Cover	27
Prerequisites.	27
Procedure	27
Replacing the Base Cover	29
Procedure	29
Postrequisites.	29
Removing the Coin-Cell Battery	30
Prerequisites.	30
Procedure	30
Replacing the Coin-Cell Battery	31
Procedure	31
Postrequisites.	31
Removing the Wireless Card	32
Prerequisites.	32
Procedure	32
Replacing the Wireless Card	33
Procedure	33
Postrequisites.	33
Removing the Cooling Assembly	34
Prerequisites.	34
Procedure	34
Replacing the Cooling Assembly	36
Procedure	36
Postrequisites.	36

Removing the USB Board	37
Prerequisites.	37
Procedure	37
Replacing the USB Board.	38
Procedure	38
Postrequisites.	38
Removing the Speakers	39
Prerequisites.	39
Procedure	39
Replacing the Speakers	40
Procedure	40
Postrequisites.	40
Removing the System Board.	41
Prerequisites.	41
Procedure	42
Replacing the System Board	45
Procedure.	45
Postrequisites.	46
Removing the Palm Rest	47
Prerequisites.	47
Procedure	48
Replacing the Palm Rest	51
Procedure	51
Postrequisites.	51
Removing the Display Assembly.	52
Prerequisites.	52
Procedure	52
Replacing the Display Assembly	56
Procedure	56
Postrequisites.	56

Removing the Power-Adapter Port	57
Prerequisites.	57
Procedure	58
Replacing the Power-Adapter Port	59
Procedure	59
Postrequisites.	59
Flashing the BIOS.	60

Before Working Inside Your Computer

Before You Begin

 **CAUTION:** To avoid data loss, save and close all open files and exit all open programs before turning off your computer.

- 1 Save and close all open files, exit all open programs, and turn off your computer.
Microsoft Windows 8: Point to the lower/upper-right corner of the screen to open the Charms sidebar and click **Settings**→ **Power**→ **Shut down**.

 **NOTE:** If you are using a different operating system, see the documentation of your operating system for shut-down instructions.

- 2 After the computer shuts down, disconnect it from the electrical outlet.
- 3 Disconnect all cables — such as power and USB cables — from your computer.
- 4 Disconnect all peripherals from your computer.









Recommended Tools

The procedures in this document may require the following tools:

- Phillips screwdriver
- Plastic scribe

Safety Instructions

Use the following safety guidelines to protect your computer from potential damage and make sure your personal safety.

-  **WARNING:** Before working inside your computer, read the safety information that shipped with your computer. For additional safety best practices, see the Regulatory Compliance at dell.com/regulatory_compliance.
-  **WARNING:** Disconnect all power sources before opening the computer cover or panels. After you finish working inside the computer, replace all covers, panels, and screws before connecting to the power source.
-  **CAUTION:** Only a certified service technician is authorized to remove the computer cover and access any of the components inside the computer.
-  **CAUTION:** To avoid damaging the computer, make sure that the work surface is flat and clean.
-  **CAUTION:** To disconnect a network cable, first unplug the cable from your computer and then unplug the cable from the network device.
-  **CAUTION:** When you disconnect a cable, pull on its connector or on its pull-tab, not on the cable itself. Some cables have connectors with locking tabs or thumb-screws that you must disengage before disconnecting the cable. When disconnecting cables, keep them evenly aligned to avoid bending any connector pins. When connecting cables, make sure that the connectors and ports are correctly oriented and aligned.
-  **CAUTION:** Before touching anything inside your computer, ground yourself by touching an unpainted metal surface, such as the metal at the back of the computer. While you work, periodically touch an unpainted metal surface to dissipate static electricity, which could harm internal components.
-  **CAUTION:** To avoid damaging the components and cards, handle them by their edges and avoid touching pins and contacts.

After Working Inside Your Computer



CAUTION: Leaving stray or loose screws inside your computer may severely damage your computer.

- 1** Replace all screws and make sure that no stray screws remain inside your computer.
- 2** Connect any cables, peripherals, and any other part(s) you removed before working on your computer.
- 3** Connect your computer to the electrical outlet.
- 4** Turn on your computer.

Removing the Battery

⚠ WARNING: Before working inside your computer, read the safety information that shipped with your computer and follow the steps in "Before Working Inside Your Computer" on page 7. After working inside your computer, follow the instructions in "After Working Inside Your Computer" on page 9. For more safety best practices, see the Regulatory Compliance home page at dell.com/regulatory_compliance.

Procedure

- 1 Close the display and turn the computer over.
- 2 Remove the screw that secures the battery cover to the computer base.
- 3 Loosen the captive screw that secures the battery cover to the computer base.
- 4 Pry out the battery cover from the computer base.

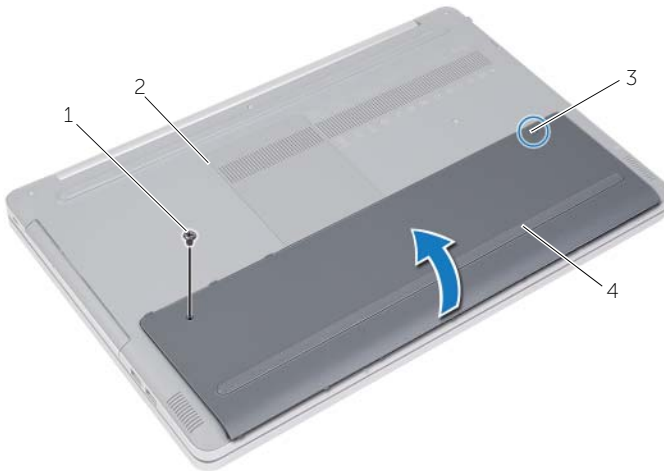

1	screw	2	computer base
3	captive screw	4	battery cover

- 5 Remove the screws that secure the battery to the computer base.
- 6 Using the pull tab, lift the battery out of the computer base.



1	screws (2)	2	pull tab
3	battery		

Replacing the Battery



WARNING: Before working inside your computer, read the safety information that shipped with your computer and follow the steps in "Before Working Inside Your Computer" on page 7. After working inside your computer, follow the instructions in "After Working Inside Your Computer" on page 9. For more safety best practices, see the Regulatory Compliance home page at dell.com/regulatory_compliance.

Procedure

- 1 Align the screw holes on the battery with the screw holes on the computer base and place the battery on the computer base.
- 2 Replace the screws that secure the battery to the computer base.
- 3 Align the screw holes on the battery cover with the screw holes on the computer base.
- 4 Tighten the captive screw that secures the battery cover to the computer base.

Removing the Memory Module(s)

⚠ WARNING: Before working inside your computer, read the safety information that shipped with your computer and follow the steps in "Before Working Inside Your Computer" on page 7. After working inside your computer, follow the instructions in "After Working Inside Your Computer" on page 9. For more safety best practices, see the Regulatory Compliance home page at dell.com/regulatory_compliance.

Prerequisites

Remove the battery. See "Removing the Battery" on page 10.

Procedure

- 1 Pry the memory-module cover off the computer base.

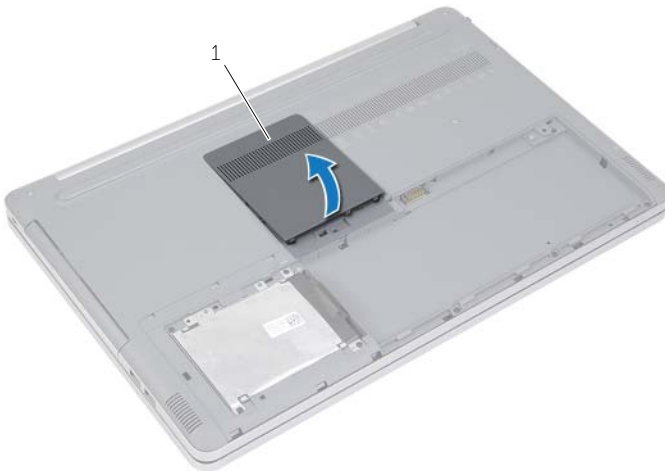

1 memory-module cover

- 2 Carefully spread apart the securing clips on each end of the memory-module connector until the memory module pops up.
- 3 Remove the memory module from the computer.

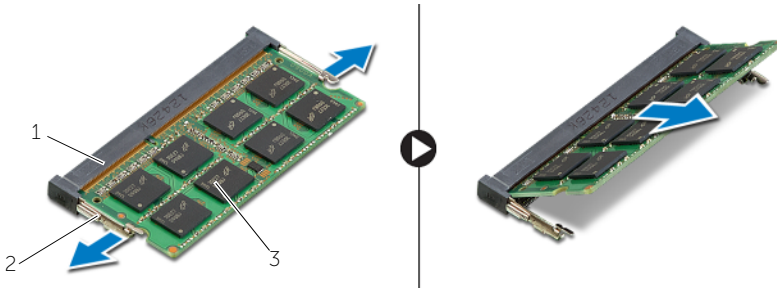

1	memory-module connector	2	securing clips (2)
3	memory module		

Replacing the Memory Module(s)

⚠ WARNING: Before working inside your computer, read the safety information that shipped with your computer and follow the steps in "Before Working Inside Your Computer" on page 7. After working inside your computer, follow the instructions in "After Working Inside Your Computer" on page 9. For more safety best practices, see the Regulatory Compliance home page at dell.com/regulatory_compliance.

Procedure

- 1 Align the notch on the memory module with the tab on the memory-module connector.
- 2 Slide the memory module into the connector at an angle, and press the memory module down until it clicks into place.
🔧 NOTE: If you do not hear the click, remove the memory module and re-install it.
- 3 Replace the memory-module cover.

Postrequisites.

Replace the battery. See "Replacing the Battery" on page 12.

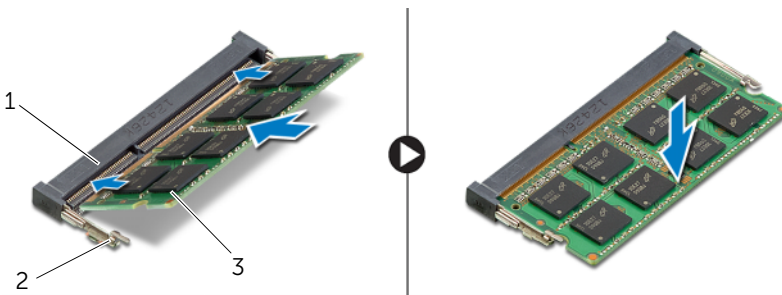

1 memory-module connector
3 memory module

2 securing clips (2)

Removing the Optical Drive

⚠ WARNING: Before working inside your computer, read the safety information that shipped with your computer and follow the steps in "Before Working Inside Your Computer" on page 7. After working inside your computer, follow the instructions in "After Working Inside Your Computer" on page 9. For more safety best practices, see the Regulatory Compliance home page at dell.com/regulatory_compliance.

Prerequisites

Remove the battery. See "Removing the Battery" on page 10.

Procedure

- 1 Pry the memory-module cover off the computer base.

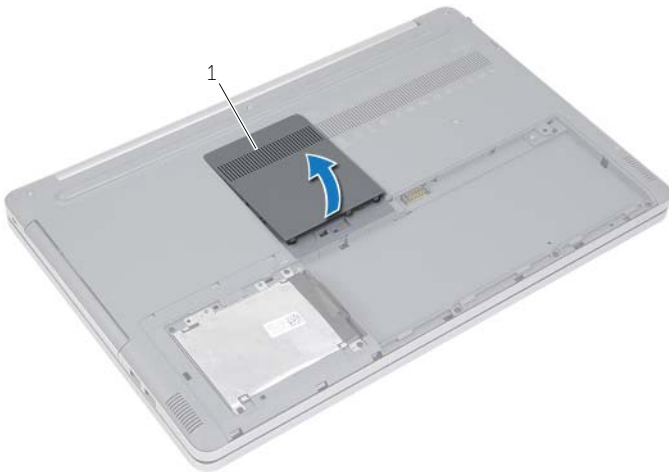

1 memory-module cover

- 2 Remove the screw that secures the optical-drive assembly to the computer base.
- 3 Using a plastic scribe, push the optical-drive assembly out of the optical-drive bay.



1	optical-drive assembly	2	screw
3	plastic scribe		

- 4 Remove the screw that secures the optical-drive bracket to the optical drive and remove the optical-drive bracket.
- 5 Carefully pull the optical-drive bezel and remove it from the optical drive.

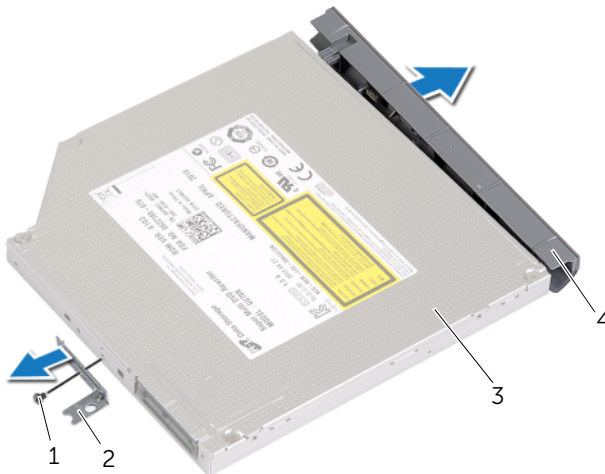

1	screw	2	optical-drive bracket
3	optical drive	4	optical-drive bezel

Replacing the Optical Drive



WARNING: Before working inside your computer, read the safety information that shipped with your computer and follow the steps in "Before Working Inside Your Computer" on page 7. After working inside your computer, follow the instructions in "After Working Inside Your Computer" on page 9. For more safety best practices, see the Regulatory Compliance home page at dell.com/regulatory_compliance.

Procedure

- 1 Connect the optical-drive bezel to the optical-drive.
- 2 Align the screw hole on the optical-drive bracket with the screw hole on the optical drive.
- 3 Replace the screw that secures the optical-drive bracket to the optical drive.
- 4 Slide the optical-drive assembly into the optical drive bay.
- 5 Replace the screw that secures the optical drive to the computer base.
- 6 Replace the memory-module cover.

Postrequisites

Replace the battery. See "Replacing the Battery" on page 12.

Removing the Hard Drive

! **WARNING:** Before working inside your computer, read the safety information that shipped with your computer and follow the steps in "Before Working Inside Your Computer" on page 7. After working inside your computer, follow the instructions in "After Working Inside Your Computer" on page 9. For more safety best practices, see the Regulatory Compliance home page at dell.com/regulatory_compliance.

△ **CAUTION:** To avoid data loss, do not remove the hard drive while the computer is in Sleep or On state.

△ **CAUTION:** Hard drives are extremely fragile. Exercise care when handling the hard drive.

Prerequisites

Remove the battery. See "Removing the Battery" on page 10.

Procedure

- 1 Remove the screws that secure the hard-drive assembly to the computer base.
- 2 Using the pull tab, lift the hard-drive assembly.
- 3 Disconnect the hard-drive cable and lift the hard-drive assembly off the computer base.

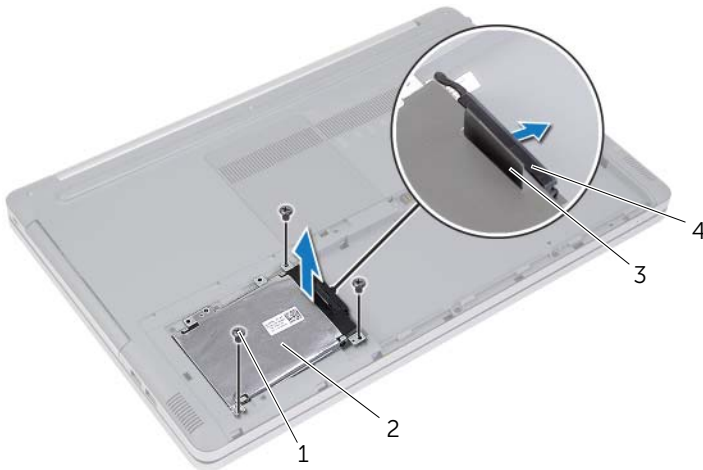

1 screws (3)

2 hard-drive assembly

3 pull tab

4 hard-drive cable

- 4 Remove the screws that secure the hard-drive cage to the hard drive assembly.
- 5 Using the pull-tab, lift the hard-drive cage off the hard drive.



1	pull tab	2	hard-drive cage
3	hard drive	4	screws (4)

Replacing the Hard Drive

 **WARNING:** Before working inside your computer, read the safety information that shipped with your computer and follow the steps in "Before Working Inside Your Computer" on page 7. After working inside your computer, follow the instructions in "After Working Inside Your Computer" on page 9. For more safety best practices, see the Regulatory Compliance home page at dell.com/regulatory_compliance.

 **CAUTION:** Hard drives are extremely fragile. Exercise care when handling the hard drive.

Procedure

- 1 Align the screw holes on the hard-drive cage with the screw holes on the hard drive.
- 2 Replace the screws that secure the hard-drive cage to the hard drive.
- 3 Connect the hard-drive cable to the hard-drive assembly.
- 4 Place the hard-drive assembly on the computer base and slide the hard-drive assembly into place.
- 5 Replace the screws that secure the hard-drive assembly to the computer base.

Postrequisites.

Replace the battery. See "Replacing the Battery" on page 12.

Removing the Keyboard

⚠ WARNING: Before working inside your computer, read the safety information that shipped with your computer and follow the steps in "Before Working Inside Your Computer" on page 7. After working inside your computer, follow the instructions in "After Working Inside Your Computer" on page 9. For more safety best practices, see the Regulatory Compliance home page at dell.com/regulatory_compliance.

Prerequisites

Remove the battery. See "Removing the Battery" on page 10.

Procedure

- 1 Pry out the memory-module cover from the computer base.

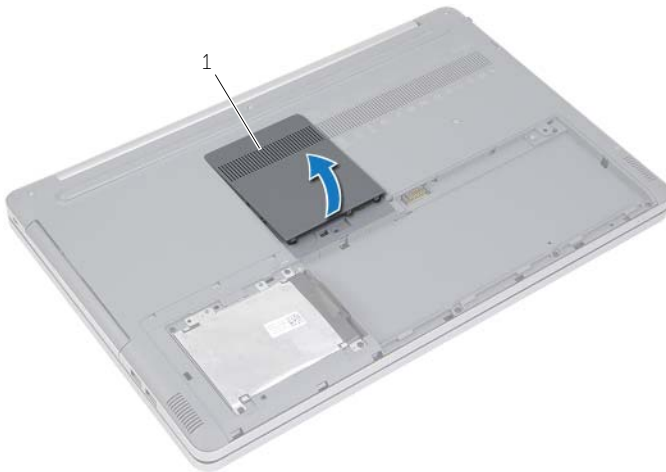

1 memory-module cover

2 Remove the screw which secures the keyboard to the computer base.

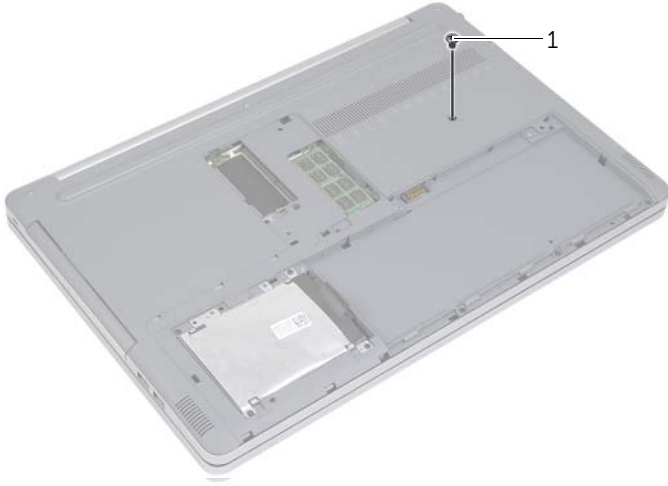

1 screw

- 3 Turn the computer over.
- 4 Using a plastic scribe, gently release the keyboard from the tabs on the palm-rest assembly.

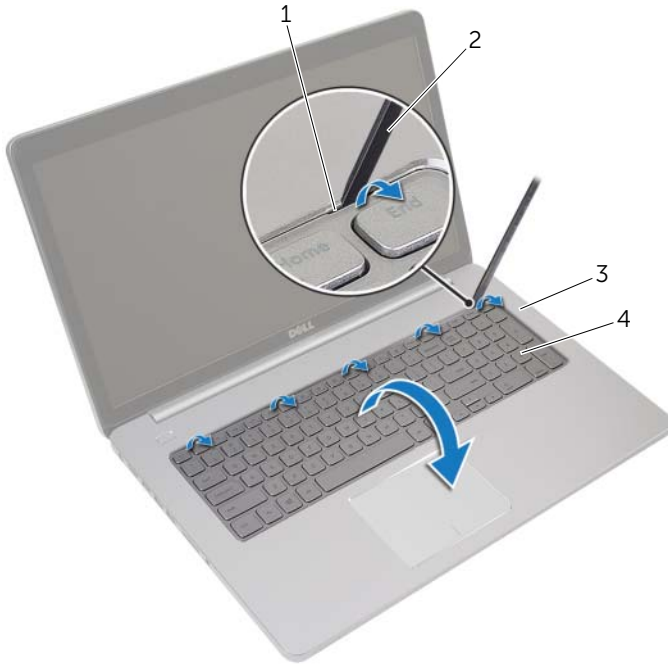

1	tabs (5)	2	plastic scribe
3	palm rest	4	keyboard

- 5 Carefully turn the keyboard over and place it on the palm rest.
- 6 Lift the latch and disconnect the keyboard cable from the system board.
- 7 Lift the latch and disconnect the keyboard-backlight cable from the system board.
- 8 Lift the keyboard off the palm rest.

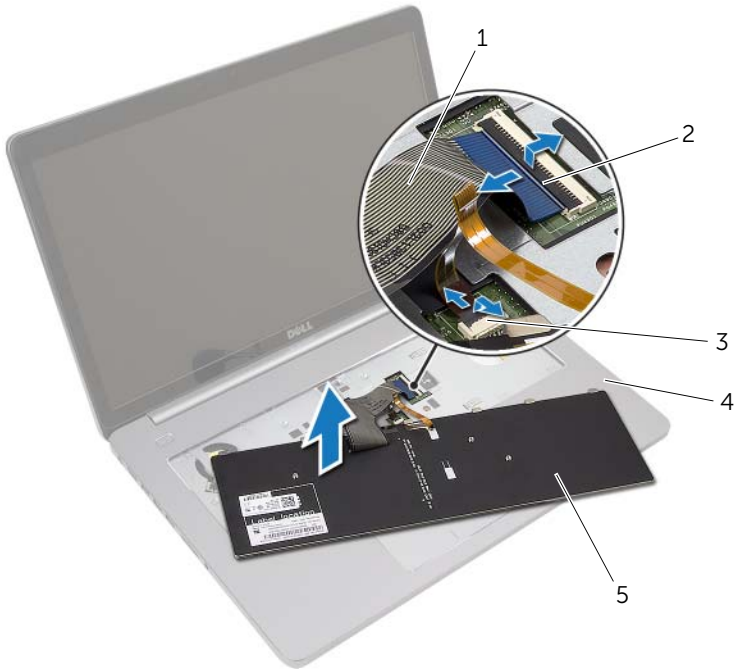

1	keyboard cable	2	latches (2)
3	keyboard-backlight cable	4	palm rest
5	keyboard		

Replacing the Keyboard



WARNING: Before working inside your computer, read the safety information that shipped with your computer and follow the steps in "Before Working Inside Your Computer" on page 7. After working inside your computer, follow the instructions in "After Working Inside Your Computer" on page 9. For more safety best practices, see the Regulatory Compliance home page at dell.com/regulatory_compliance.

Procedure

- 1 Slide the keyboard-backlight cable into the keyboard-backlight cable connector and press down the latch to secure the cable.
- 2 Slide the keyboard cable into the keyboard-cable connector and press down on the latch to secure the cable.
- 3 Slide the tabs on the keyboard into the slots on the palm-rest and snap the keyboard on the palm rest.
- 4 Replace the screws that secure the keyboard to the computer base.
- 5 Turn the computer over and replace the screws that secure the keyboard to the computer base.
- 6 Replace the memory-module cover.

Postrequisites

Replace the battery. See "Replacing the Battery" on page 12.

Removing the Base Cover

⚠ WARNING: Before working inside your computer, read the safety information that shipped with your computer and follow the steps in "Before Working Inside Your Computer" on page 7. After working inside your computer, follow the instructions in "After Working Inside Your Computer" on page 9. For more safety best practices, see the Regulatory Compliance home page at dell.com/regulatory_compliance.

Prerequisites

- 1 Remove the battery. See "Removing the Battery" on page 10.
- 2 Follow the instructions from step 1 to step 3 in "Removing the Optical Drive" on page 16.
- 3 Follow the instructions from step 1 to step 3 in "Removing the Hard Drive" on page 19.
- 4 Remove the keyboard. See "Removing the Keyboard" on page 22.

Procedure

- 1 Remove the screws that secure the base cover to the computer base.

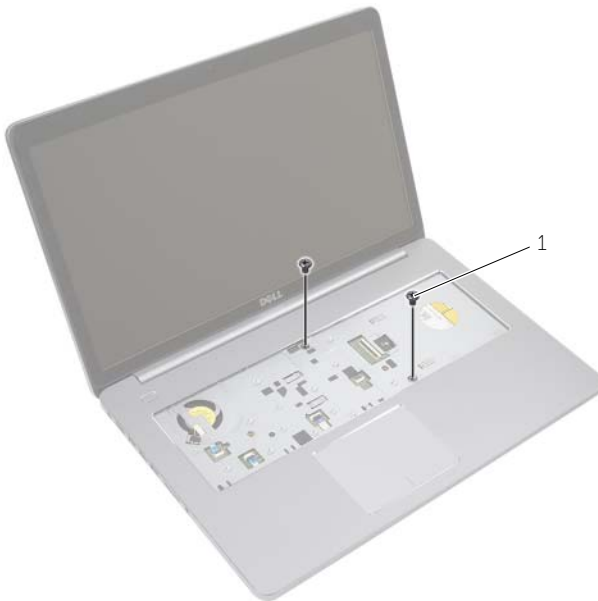

1 screws (2)

- 2 Turn the computer over and remove the screws that secure the base cover to the computer base.

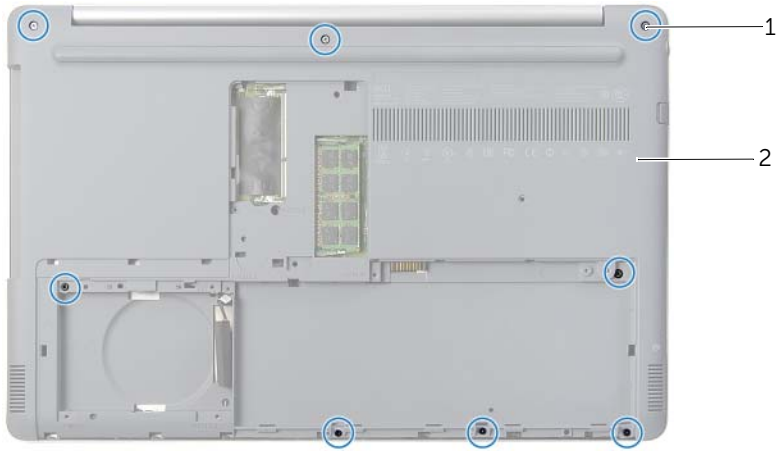

1 screws (8)

2 base cover

- 3 Pry the base cover away from the computer base.



1 base cover

2 plastic scribe

Replacing the Base Cover



WARNING: Before working inside your computer, read the safety information that shipped with your computer and follow the steps in "Before Working Inside Your Computer" on page 7. After working inside your computer, follow the instructions in "After Working Inside Your Computer" on page 9. For more safety best practices, see the Regulatory Compliance home page at dell.com/regulatory_compliance.

Procedure

- 1 Place the base cover on the computer base and snap it in place.
- 2 Replace the screws that secure the base cover to the computer base.

Postrequisites

- 1 Replace the keyboard. See "Replacing the Keyboard" on page 26.
- 2 Follow the instructions from step 4 to step 6 in "Replacing the Optical Drive" on page 18.
- 3 Follow the instructions from step 3 to step 5 in "Replacing the Hard Drive" on page 21.
- 4 Replace the optical-drive assembly. See "Replacing the Optical Drive" on page 18.
- 5 Replace the battery. See "Replacing the Battery" on page 12.

Removing the Coin-Cell Battery

⚠ WARNING: Before working inside your computer, read the safety information that shipped with your computer and follow the steps in "Before Working Inside Your Computer" on page 7. After working inside your computer, follow the instructions in "After Working Inside Your Computer" on page 9. For more safety best practices, see the Regulatory Compliance home page at dell.com/regulatory_compliance.

⚠ CAUTION: Removing the coin-cell battery resets the BIOS settings to default. It is recommended that you note the BIOS settings before removing the coin-cell battery.

Prerequisites

- 1 Remove the battery. See "Removing the Battery" on page 10.
- 2 Remove the optical-drive assembly. See "Removing the Optical Drive" on page 16.
- 3 Remove the hard-drive assembly. See "Removing the Hard Drive" on page 19.
- 4 Remove the keyboard. See "Removing the Keyboard" on page 22.
- 5 Remove the base cover. See "Removing the Base Cover" on page 27.

Procedure

Using a plastic scribe, gently pry out the coin-cell battery out of the battery socket on the system board.

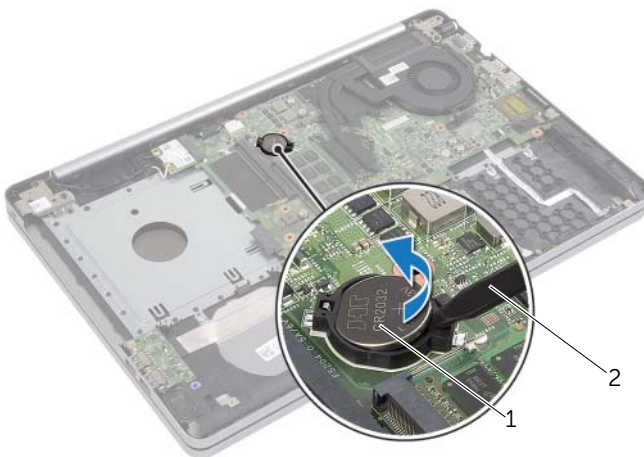

1 coin-cell battery

2 plastic scribe

Replacing the Coin-Cell Battery

 **WARNING:** Before working inside your computer, read the safety information that shipped with your computer and follow the steps in "Before Working Inside Your Computer" on page 7. After working inside your computer, follow the instructions in "After Working Inside Your Computer" on page 9. For more safety best practices, see the Regulatory Compliance home page at dell.com/regulatory_compliance.

 **WARNING:** The battery may explode if installed incorrectly. Replace the battery only with the same or equivalent type. Discard used batteries according to the manufacturer's instructions.

Procedure

With the positive-side facing up, snap the coin-cell battery into the battery socket on the system board.

Postrequisites

- 1 Replace the base-cover. "Replacing the Base Cover" on page 29.
- 2 Replace the keyboard. See "Replacing the Keyboard" on page 26.
- 3 Replace the hard-drive assembly. See "Replacing the Hard Drive" on page 21.
- 4 Replace the optical drive assembly. See "Replacing the Optical Drive" on page 18.
- 5 Replace the battery. See "Replacing the Battery" on page 12.

Removing the Wireless Card

⚠ WARNING: Before working inside your computer, read the safety information that shipped with your computer and follow the steps in "Before Working Inside Your Computer" on page 7. After working inside your computer, follow the instructions in "After Working Inside Your Computer" on page 9. For more safety best practices, see the Regulatory Compliance home page at dell.com/regulatory_compliance.

Prerequisites

- 1 Remove the battery. See "Removing the Battery" on page 10.
- 2 Remove the optical-drive assembly. See "Removing the Optical Drive" on page 16.
- 3 Remove the hard-drive assembly. See "Removing the Hard Drive" on page 19
- 4 Remove the keyboard. See "Removing the Keyboard" on page 22.
- 5 Remove the base-cover. See "Removing the Base Cover" on page 27.

Procedure

- 1 Disconnect the antenna cables from the wireless mini-card.
- 2 Push the tab to release the wireless card.
- 3 Slide and remove the wireless card from the mini-card connector.



1	tab	2	wireless card
3	antenna cables (2)	4	mini-card connector

Replacing the Wireless Card

 **WARNING:** Before working inside your computer, read the safety information that shipped with your computer and follow the steps in "Before Working Inside Your Computer" on page 7. After working inside your computer, follow the instructions in "After Working Inside Your Computer" on page 9. For more safety best practices, see the Regulatory Compliance home page at dell.com/regulatory_compliance.

Procedure

 **CAUTION:** To avoid damage to the wireless mini-card, make sure that no cables are placed under the wireless mini-card.

- 1 Align the notch on the wireless card with the tab on the mini-card connector.
- 2 Insert the wireless card at an angle into the mini-card connector.
- 3 Press the other end of the wireless card down to secure it in the tab.
- 4 Connect the antenna cables to the wireless card.

The following table provides the antenna cable color schemes for the wireless card supported by your computer.

Connectors on the wireless mini-card	Antenna-cable color
Main (white triangle)	White
Auxiliary (black triangle)	Black

Postrequisites

- 1 Replace the base cover. See "Replacing the Base Cover" on page 29.
- 2 Replace the keyboard. See "Replacing the Keyboard" on page 26.
- 3 Replace the hard-drive assembly. See "Replacing the Hard Drive" on page 21.
- 4 Replace the optical-drive assembly. See "Replacing the Optical Drive" on page 18.
- 5 Replace the battery. See "Replacing the Battery" on page 12.

Removing the Cooling Assembly

⚠ WARNING: Before working inside your computer, read the safety information that shipped with your computer and follow the steps in "Before Working Inside Your Computer" on page 7. After working inside your computer, follow the instructions in "After Working Inside Your Computer" on page 9. For more safety best practices, see the Regulatory Compliance home page at dell.com/regulatory_compliance.

Prerequisites

- 1 Remove the battery. See "Removing the Battery" on page 10.
- 2 Remove the optical drive. See "Removing the Optical Drive" on page 16.
- 3 Remove the hard drive. See "Removing the Hard Drive" on page 19.
- 4 Remove the keyboard. See "Removing the Keyboard" on page 22.
- 5 Remove the base cover. See "Removing the Base Cover" on page 27.

Procedure

- 1 Peel off the adhesive tape from the display-cable connector.
- 2 Lift the latch and disconnect the display cable from the system board.
- 3 Note the routing and remove the display cable from its routing guides on the fan.

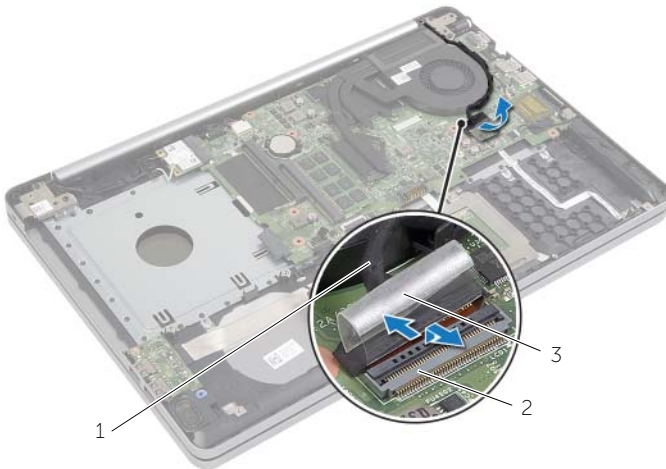

1 display cable

2 latch

3 tape

- 4 Disconnect the fan cable from the system board.
- 5 In sequential order, (indicated on the cooling assembly), loosen the captive screws that secure the cooling assembly to the system board.
- 6 Lift the cooling assembly off the system board.

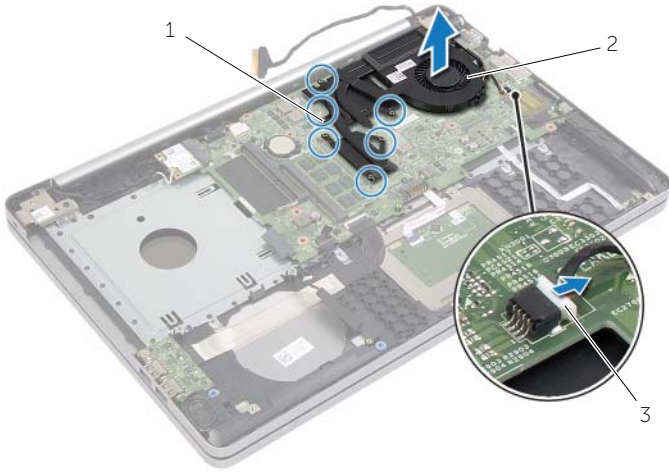

1	captive screws (6)	2	cooling assembly
3	fan cable		

Replacing the Cooling Assembly



WARNING: Before working inside your computer, read the safety information that shipped with your computer and follow the steps in "Before Working Inside Your Computer" on page 7. After working inside your computer, follow the instructions in "After Working Inside Your Computer" on page 9. For more safety best practices, see the Regulatory Compliance home page at dell.com/regulatory_compliance.

Procedure

- 1 Align the screws on the cooling assembly with the screw holes on the system board.
- 2 Tighten the captive screws that secure the cooling assembly to the system board.
- 3 Connect the fan cable to the system board.
- 4 Connect the display cable to the system board.
- 5 Route the display cable through its routing guide on the fan.

Postrequisites

- 1 Replace the base cover. See "Replacing the Base Cover" on page 29.
- 2 Replace the keyboard. See "Replacing the Keyboard" on page 26.
- 3 Replace the hard drive. See "Replacing the Hard Drive" on page 21.
- 4 Replace the optical drive. See "Replacing the Optical Drive" on page 18.
- 5 Replace the battery. See "Replacing the Battery" on page 12.

Removing the USB Board

⚠ WARNING: Before working inside your computer, read the safety information that shipped with your computer and follow the steps in "Before Working Inside Your Computer" on page 7. After working inside your computer, follow the instructions in "After Working Inside Your Computer" on page 9. For more safety best practices, see the Regulatory Compliance home page at dell.com/regulatory_compliance.

Prerequisites

- 1 Remove the battery. See "Removing the Battery" on page 10.
- 2 Remove the optical-drive assembly. See "Removing the Optical Drive" on page 16.
- 3 Remove the hard-drive assembly. See "Removing the Hard Drive" on page 19.
- 4 Remove the keyboard. See "Removing the Keyboard" on page 22.
- 5 Remove the base cover. See "Removing the Base Cover" on page 27.

Procedure

- 1 Remove the screw that secures the USB board to the computer base.
- 2 Turn the USB board over and peel off the tape from the USB-board cable.
- 3 Lift the connector latch and disconnect the USB-board cable from the USB board.
- 4 Lift the USB board off the computer base.

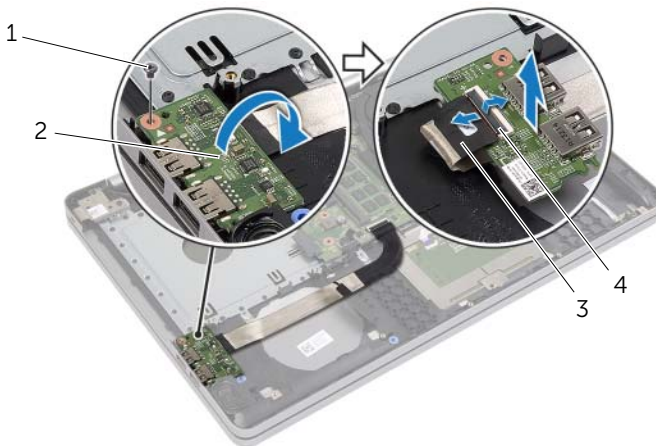

1 screw

2 USB board

3 USB-board cable

4 connector latch

Replacing the USB Board



WARNING: Before working inside your computer, read the safety information that shipped with your computer and follow the steps in "Before Working Inside Your Computer" on page 7. After working inside your computer, follow the instructions in "After Working Inside Your Computer" on page 9. For more safety best practices, see the Regulatory Compliance home page at dell.com/regulatory_compliance.

Procedure

- 1 Connect the USB-board cable to the USB board and press down the latch to secure the cable.
- 2 Adhere the tape over the USB-board cable.
- 3 Using the alignment posts on the computer base, place the USB board in position.
- 4 Replace the screw that secures the USB board to the computer base.

Postrequisites

- 1 Replace the base cover. See "Replacing the Base Cover" on page 29.
- 2 Replace the keyboard. See "Replacing the Keyboard" on page 26.
- 3 Replace the hard-drive assembly. See "Replacing the Hard Drive" on page 21.
- 4 Replace the optical-drive assembly. See "Replacing the Optical Drive" on page 18.
- 5 Replace the battery. See "Replacing the Battery" on page 12.

Removing the Speakers

⚠ WARNING: Before working inside your computer, read the safety information that shipped with your computer and follow the steps in "Before Working Inside Your Computer" on page 7. After working inside your computer, follow the instructions in "After Working Inside Your Computer" on page 9. For additional safety best practices information, see the Regulatory Compliance Homepage at dell.com/regulatory_compliance.

Prerequisites

- 1 Remove the battery. See "Removing the Battery" on page 10.
- 2 Remove the optical drive. See "Removing the Optical Drive" on page 16.
- 3 Remove the hard drive. See "Removing the Hard Drive" on page 19.
- 4 Remove the base cover. See "Removing the Base Cover" on page 27.
- 5 Remove the keyboard. See "Removing the Keyboard" on page 22

Procedure

- 1 Using a plastic scribe, release the tabs on the right speaker.
- 2 Note the speaker-cable routing and remove the cable from its routing guides.
- 3 Disconnect the speaker cable from the system board.
- 4 Lift the speakers, along with the speaker cable, off the computer base.

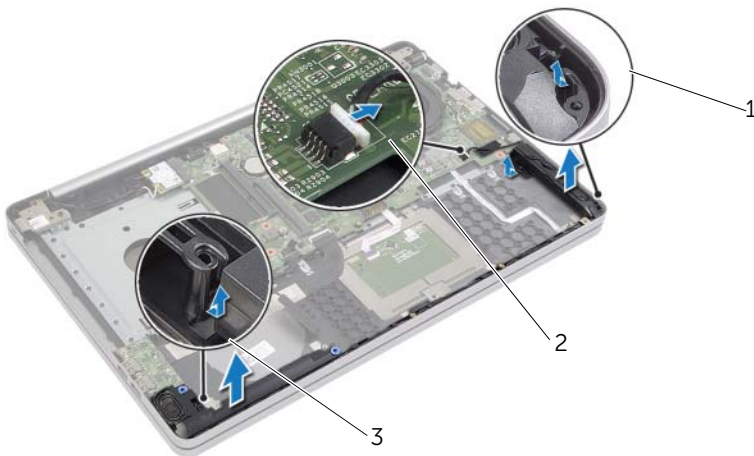

1 speakers (2)

2 speaker cable

3 tab

Replacing the Speakers



WARNING: Before working inside your computer, read the safety information that shipped with your computer and follow the steps in "Before Working Inside Your Computer" on page 7. After working inside your computer, follow the instructions in "After Working Inside Your Computer" on page 9. For more safety best practices, see the Regulatory Compliance home page at dell.com/regulatory_compliance.

Procedure

- 1 Using the alignment posts on the computer base, place the speakers in position.
- 2 Route the speaker cable through the routing guides on the computer base.
- 3 Connect the speaker cable to the system board.

Postrequisites

- 1 Replace the base cover. See "Replacing the Base Cover" on page 29.
- 2 Replace the keyboard. See "Replacing the Keyboard" on page 26.
- 3 Replace the optical drive. See "Replacing the Optical Drive" on page 18.
- 4 Replace the hard drive. See "Replacing the Hard Drive" on page 21.
- 5 Replace the battery. See "Replacing the Battery" on page 12.

Removing the System Board

 **WARNING:** Before working inside your computer, read the safety information that shipped with your computer and follow the steps in "Before Working Inside Your Computer" on page 7. After working inside your computer, follow the instructions in "After Working Inside Your Computer" on page 9. For more safety best practices, see the Regulatory Compliance home page at dell.com/regulatory_compliance.

 **NOTE:** Your computer's Service Tag is stored in the system board. You must enter the Service Tag in System Setup after you replace the system board.

 **NOTE:** Before disconnecting the cables from the system board, note the location of the connectors so that you can reconnect them correctly after you replace the system board.

Prerequisites

- 1 Remove the battery. See "Removing the Battery" on page 10.
- 2 Remove the memory modules. See "Removing the Memory Module(s)" on page 13.
- 3 Remove the optical-drive assembly. See "Removing the Optical Drive" on page 16.
- 4 Remove the hard-drive assembly. See "Removing the Hard Drive" on page 19.
- 5 Remove the keyboard. See "Removing the Keyboard" on page 22.
- 6 Remove the base cover. See "Removing the Base Cover" on page 27.
- 7 Remove the wireless card. See "Removing the Wireless Card" on page 32.
- 8 Remove the USB board. See "Removing the USB Board" on page 37.
- 9 Remove the cooling assembly. See "Removing the Cooling Assembly" on page 34.
- 10 Remove the coin-cell battery. See "Removing the Coin-Cell Battery" on page 30.

Procedure

- 1 Turn the computer over, and open the display .
- 2 Lift the latch and disconnect the status-light cable..
- 3 Lift the latch and disconnect the touchpad cable.
- 4 Lift the latch and disconnect the power-button cable.

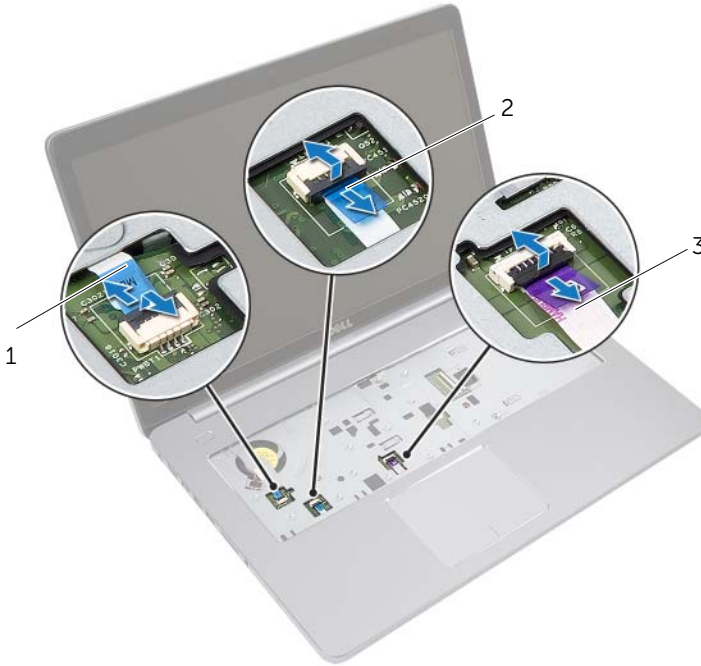

1	power-button cable	2	status-light cable
3	touchpad cable		

- 5 Turn the computer over.
- 6 Peel off the tape from the USB-board cable.
- 7 Lift the connector latch and, using the pull-tab, disconnect the USB-board cable from the system board.
- 8 Disconnect the speaker cable from the system board.
- 9 Disconnect the hard-drive cable from the system board.
- 10 Disconnect the power-adaptor port cable from the system board.
- 11 Disconnect the camera cable from the system board.

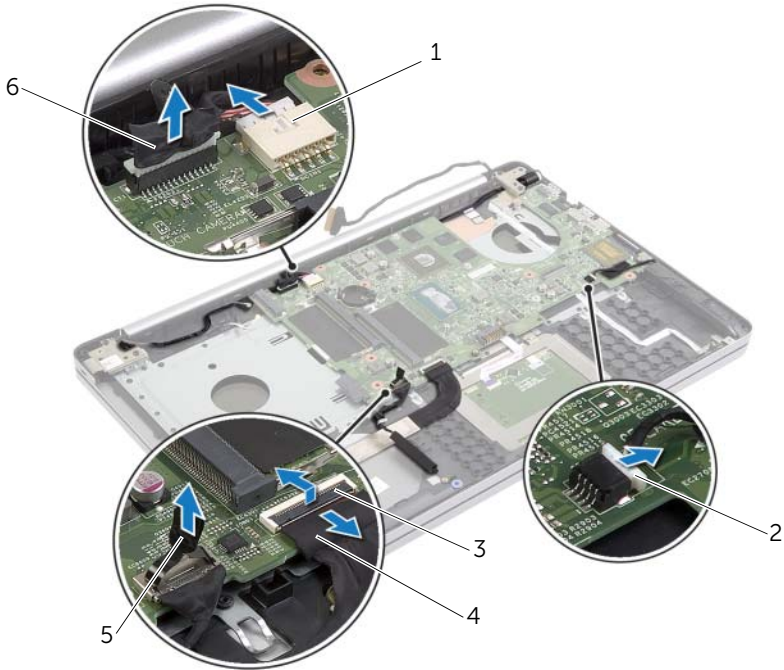

1	power-adaptor port cable	2	speaker cable
3	latch	4	USB-board cable
5	hard-drive cable	6	camera cable

- 12 Remove the screw that secures the system board to the computer base.
- 13 Lift the system-board at 45-degree angle and release the system-board ports from the slots on the computer base.
- 14 Lift the system-board assembly off the computer base.

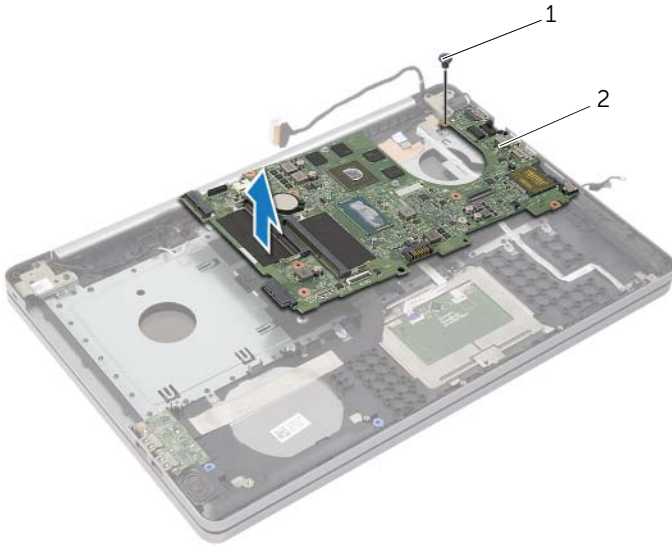

1 screw	2 system-board assembly
---------	-------------------------

Replacing the System Board



WARNING: Before working inside your computer, read the safety information that shipped with your computer and follow the steps in "Before Working Inside Your Computer" on page 7. After working inside your computer, follow the instructions in "After Working Inside Your Computer" on page 9. For more safety best practices, see the Regulatory Compliance home page at dell.com/regulatory_compliance.



NOTE: Your computer's Service Tag is stored in the system board. You must enter the Service Tag in the system setup after you replace the system board.

Procedure.

- 1 Ease the ports on the system board into the slots on the computer base and place the system board in the computer base.
- 2 Align the screw hole on the system board to the screw hole on the computer base.
- 3 Replace the screw that secures the system board to the computer base.
- 4 Connect the camera cable to the system board.
- 5 Connect the power-adapter port cable to the system board.
- 6 Connect the hard-drive cable to the hard-disc connector.
- 7 Connect the speaker cable to the system board.
- 8 Slide the USB-board cable to the USB-board connector and press down on the latch to secure the cable.
- 9 Adhere the tape over the USB-board cable.
- 10 Turn the computer over.
- 11 Connect the power-button cable to the computer base.
- 12 Connect the touchpad-board cable to the computer base.
- 13 Connect the status-light cable to the computer base.

Postrequisites

- 1 Replace the coin-cell battery. See "Replacing the Coin-Cell Battery" on page 31.
- 2 Replace the fan and heat-sink assembly. See "Replacing the Cooling Assembly" on page 36.
- 3 Replace the USB board. See "Replacing the USB Board" on page 38.
- 4 Replace the wireless card. See "Replacing the Wireless Card" on page 33.
- 5 Replace the base cover. See "Replacing the Base Cover" on page 29.
- 6 Replace the keyboard. See "Replacing the Keyboard" on page 26.
- 7 Replace the hard-drive assembly. See "Replacing the Hard Drive" on page 21.
- 8 Replace the optical-drive assembly. See "Replacing the Optical Drive" on page 18.
- 9 Replace the memory modules. See "Replacing the Memory Module(s)" on page 15.
- 10 Replace the battery. See "Replacing the Battery" on page 12.

Removing the Palm Rest



WARNING: Before working inside your computer, read the safety information that shipped with your computer and follow the steps in "Before Working Inside Your Computer" on page 7. After working inside your computer, follow the instructions in "After Working Inside Your Computer" on page 9. For more safety best practices, see the Regulatory Compliance home page at dell.com/regulatory_compliance.

Prerequisites

- 1 Remove the battery. See "Removing the Battery" on page 10.
- 2 Remove the memory modules. See "Removing the Memory Module(s)" on page 13
- 3 Remove the optical-drive assembly. See "Removing the Optical Drive" on page 16
- 4 Remove the hard-drive assembly. See "Removing the Hard Drive" on page 19.
- 5 Remove the keyboard. See "Removing the Keyboard" on page 22.
- 6 Remove the base cover. See "Removing the Base Cover" on page 27
- 7 Remove the wireless card. See "Removing the Wireless Card" on page 32.
- 8 Remove the USB board. See "Removing the USB Board" on page 37.
- 9 Remove the cooling assembly. See "Removing the Cooling Assembly" on page 34.
- 10 Remove the coin cell battery. See "Removing the Coin-Cell Battery" on page 30.
- 11 Remove the speakers. See "Removing the Speakers" on page 39.
- 12 Remove the system board. See "Removing the System Board" on page 41.
- 13 Remove the power-adaptor port. See "Removing the Power-Adapter Port" on page 57.

Procedure

- 1 Note the camera and antenna cable routing and remove the cables from the routing guides on the palm-rest assembly.
- 2 Remove the screws that secure the display hinges to the palm-rest assembly.

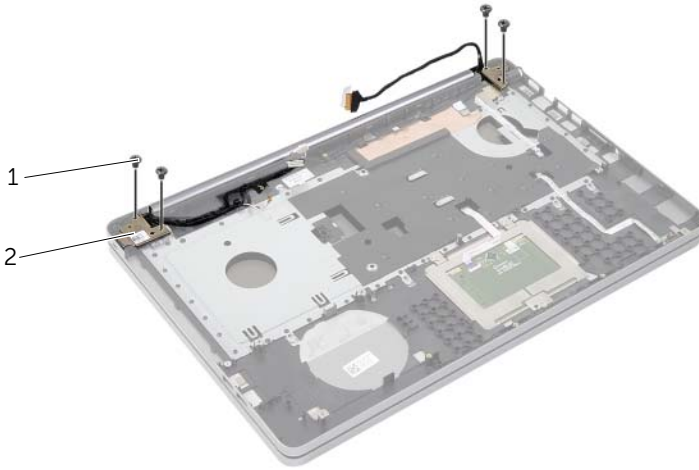

1 screws (4)

2 display hinges (2)

- 3 Lift the palm-rest away from the display assembly.

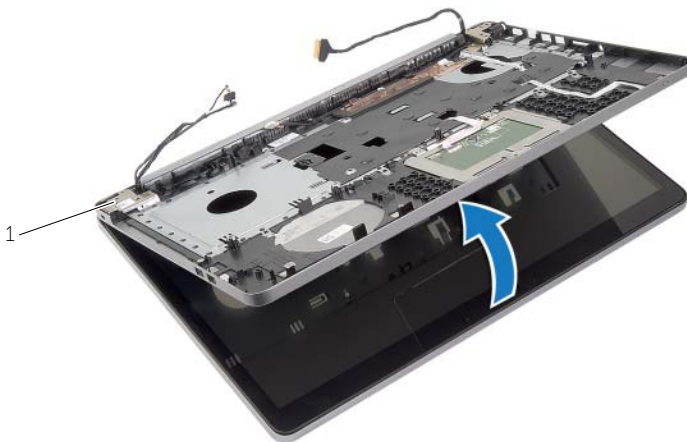

1 display hinges (2)

- 4 Gently lift and release the tabs on the palm rest from the slots on the computer base.

CAUTION: Separate the palm rest from the display assembly carefully to avoid damage to the display assembly.



- 5 Lift the palm rest off the computer base.
- 6 Peel off the USB board cable from the palm rest.
- 7 Note the hard-drive cable routing and remove the hard-drive cable from the routing guides along the palm rest.

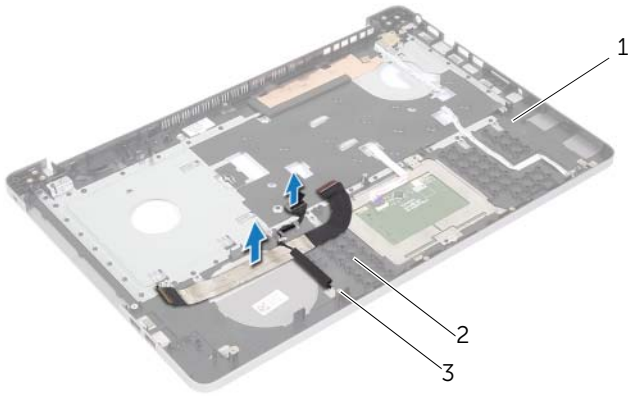

1 palm rest

2 USB board cable

3 hard-drive cable



1 palm rest

Replacing the Palm Rest



WARNING: Before working inside your computer, read the safety information that shipped with your computer and follow the steps in "Before Working Inside Your Computer" on page 7. After working inside your computer, follow the instructions in "After Working Inside Your Computer" on page 9. For more safety best practices, see the Regulatory Compliance home page at dell.com/regulatory_compliance

Procedure

- 1 Route the hard drive cable through the routing guides on the palm-rest assembly.
- 2 Connect the USB board cable to the USB board latch on the palm rest assembly
- 3 Align the slots on the computer base to the tabs on the palm-rest assembly.
- 4 Press down on the edges of the palm rest to snap it into place and close the palm-rest assembly.
- 5 Replace the screws that secure the display hinges to the palm-rest assembly
- 6 Route the camera and antenna cables through the routing guides on the palm-rest assembly.

Postrequisites

- 1 Replace the power-adapter port. See "Replacing the Power-Adapter Port" on page 59.
- 2 Replace the system board. See "Replacing the System Board" on page 45.
- 3 Replace the speakers. See "Replacing the Speakers" on page 40
- 4 Replace the coin cell battery. See "Replacing the Coin-Cell Battery" on page 31.
- 5 Replace the cooling assembly. See "Replacing the Cooling Assembly" on page 36.
- 6 Replace the USB board. See "Replacing the USB Board" on page 38
- 7 Replace the wireless minicard assembly. See "Replacing the Wireless Card" on page 33.
- 8 Replace the base cover. See "Replacing the Base Cover" on page 29.
- 9 Replace the keyboard. See "Replacing the Keyboard" on page 26.
- 10 Replace the hard-drive assembly. See "Replacing the Hard Drive" on page 21.
- 11 Replace the optical-drive assembly. See "Replacing the Optical Drive" on page 18.
- 12 Replace the memory modules. See "Replacing the Memory Module(s)" on page 15.
- 13 Replace the battery. See "Replacing the Battery" on page 12.

Removing the Display Assembly



WARNING: Before working inside your computer, read the safety information that shipped with your computer and follow the steps in "Before Working Inside Your Computer" on page 7. After working inside your computer, follow the instructions in "After Working Inside Your Computer" on page 9. For more safety best practices, see the Regulatory Compliance home page at dell.com/regulatory_compliance.

Prerequisites

- 1 Remove the battery. See "Removing the Battery" on page 10.
- 2 Remove the keyboard. See "Removing the Keyboard" on page 22.
- 3 Remove the base cover. See "Removing the Base Cover" on page 27.
- 4 Remove the optical-drive assembly. See "Removing the Optical Drive" on page 16.
- 5 Remove the hard-drive assembly. See "Removing the Hard Drive" on page 19.
- 6 Remove the wireless minicard. See "Removing the Wireless Card" on page 32.

Procedure

- 1 Disconnect the display cable from the system board.
- 2 Peel off the tape from the USB-board cable.
- 3 Lift the connector latch and, using the pull-tab, disconnect the USB-board cable from the system board.
- 4 Disconnect the speaker cable from the system board.
- 5 Disconnect the hard-drive cable from the system board.
- 6 Disconnect the power-adaptor port cable from the system board.
- 7 Disconnect the camera cable from the system board.
- 8 Remove the screw that secures the system board to the computer base.

- 9 Lift the system-board at 45-degree angle and release the system-board ports from the slots on the computer base.
- 10 Lift the system-board assembly off the computer base.

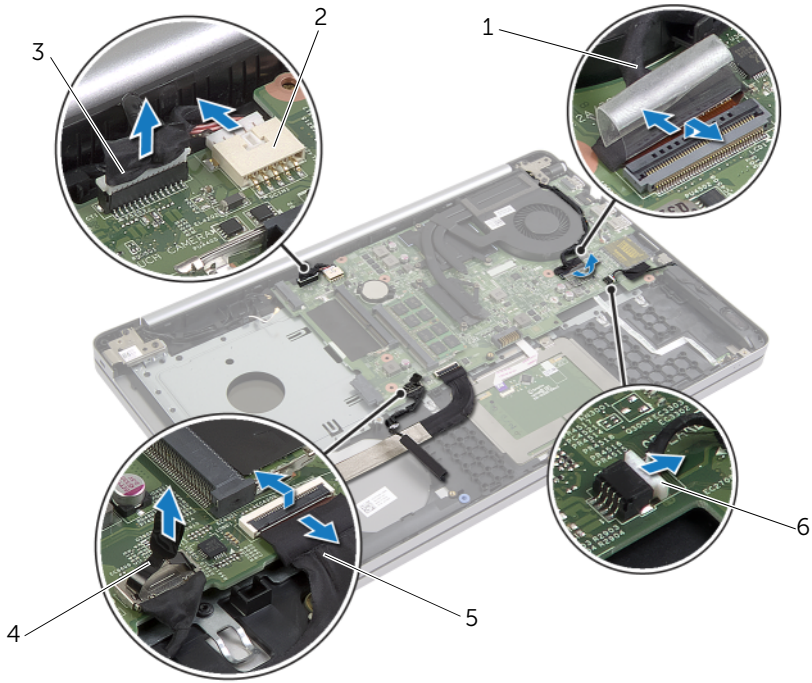

1	display cable	2	power-adaptor port cable
3	camera cable	4	hard-drive cable
5	USB-board cable	6	speaker cable

- 11 Note the camera and antenna cable routing and remove the cables from the routing guides on the palm-rest assembly.
- 12 Remove the screws that secure the display hinges to the palm-rest assembly.

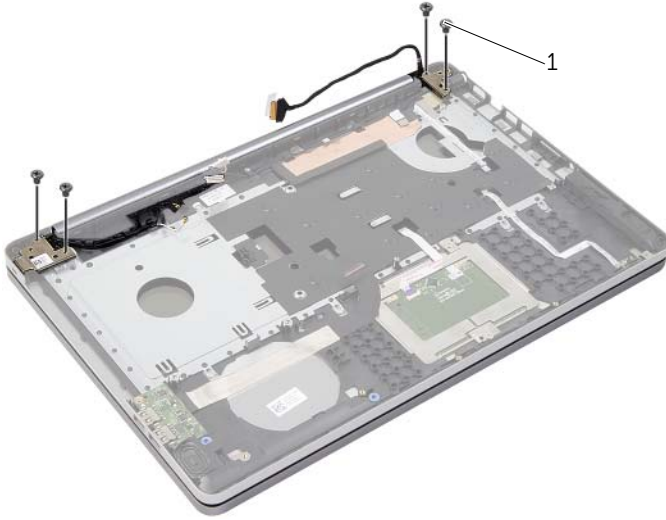

- 13 Lift the palm-rest away from the display assembly.

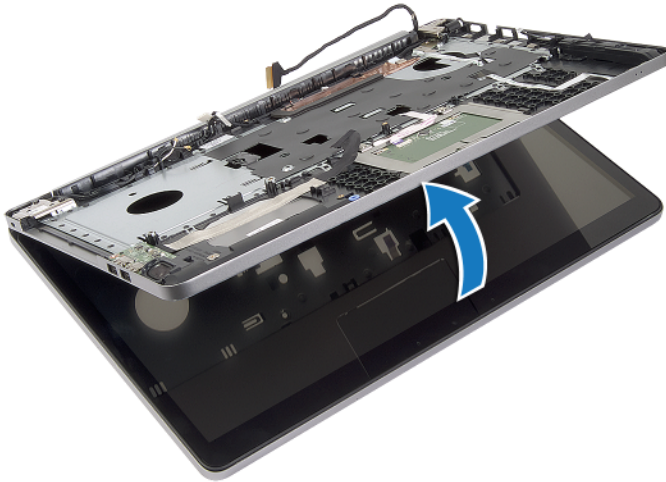

- 14 Gently lift and release the tabs on the palm rest from the slots on the computer base.

 **CAUTION:** Separate the palm rest from the display assembly carefully to avoid damage to the display assembly.



- 15 Slide and lift the palm-rest assembly to release the display assembly.



1 display assembly

Replacing the Display Assembly



WARNING: Before working inside your computer, read the safety information that shipped with your computer and follow the steps in "Before Working Inside Your Computer" on page 7. After working inside your computer, follow the instructions in "After Working Inside Your Computer" on page 9. For more safety best practices, see the Regulatory Compliance home page at dell.com/regulatory_compliance.

Procedure

- 1 Place the palm-rest assembly on the display assembly.
- 2 Align the screw holes on the palm-rest assembly with the screw holes on the display hinges and pressing down on the display hinges, close the palm-rest assembly.
- 3 Replace the screws that secure the display hinges to the palm-rest assembly.
- 4 Route the camera and antenna cables through the routing guides on the palm-rest assembly.
- 5 Replace the system-board assembly on the computer base.
- 6 Replace the screw that secures the system-board assembly on the computer base.
- 7 Connect the camera cable to the system board.
- 8 Connect the power-adaptor port cable to the system board.
- 9 Connect the hard-drive cable to the system board.
- 10 Connect the speaker cable to the system board.
- 11 Slide the USB-board cable to the connector latch and connect it to the system board by snapping it in place.
- 12 Adhere the tape to the USB-board cable.
- 13 Connect the display cable to the system board.

Postrequisites

- 1 Replace the wireless minicard assembly. See "Replacing the Wireless Card" on page 33.
- 2 Replace the base cover. See "Replacing the Base Cover" on page 29.
- 3 Replace the keyboard. See "Replacing the Keyboard" on page 26.
- 4 Replace the hard-drive assembly. See "Replacing the Hard Drive" on page 21.
- 5 Replace the optical-drive assembly. See "Replacing the Optical Drive" on page 18.
- 6 Replace the battery. See "Replacing the Battery" on page 12.

Removing the Power-Adapter Port



WARNING: Before working inside your computer, read the safety information that shipped with your computer and follow the steps in "Before Working Inside Your Computer" on page 7. After working inside your computer, follow the instructions in "After Working Inside Your Computer" on page 9. For more safety best practices, see the Regulatory Compliance home page at dell.com/regulatory_compliance.

Prerequisites

- 1 Remove the battery. See "Removing the Battery" on page 10.
- 2 Remove the optical-drive assembly. See "Removing the Optical Drive" on page 16.
- 3 Remove the hard-drive assembly. See "Removing the Hard Drive" on page 19.
- 4 Remove the base cover. See "Removing the Base Cover" on page 27.
- 5 Remove the memory module(s). See "Removing the Memory Module(s)" on page 13.
- 6 Remove the keyboard. See "Removing the Keyboard" on page 22.
- 7 Remove the palm rest. See "Removing the Palm Rest" on page 47.
- 8 Remove the wireless mini-card. See "Removing the Wireless Card" on page 32.
- 9 Remove the system board. See "Removing the System Board" on page 41.
- 10 Remove the display assembly. See "Removing the Display Assembly" on page 52.

Procedure

- 1 Release the power-adapter port cable from the routing guides on the computer base.
- 2 Remove the screw that secures the power-adapter port to the base.
- 3 Lift the power-adapter port, along with its cable, off the computer base.

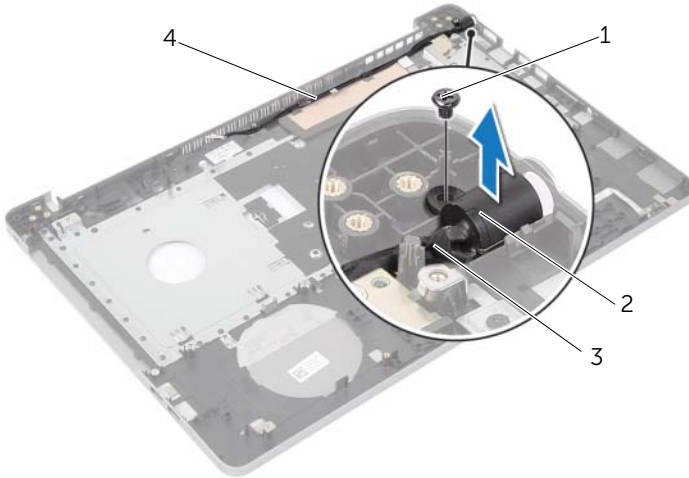

1	screw	2	power-adapter port
3	power-adapter port cable	4	routing guides

Replacing the Power-Adapter Port

 **WARNING:** Before working inside your computer, read the safety information that shipped with your computer and follow the steps in "Before Working Inside Your Computer" on page 7. After working inside your computer, follow the instructions in "After Working Inside Your Computer" on page 9. For more safety best practices, see the Regulatory Compliance home page at dell.com/regulatory_compliance.

Procedure

- 1 Slide the power-adapter port into position.
- 2 Replace the screw that secures the power-adapter port to the computer base.
- 3 Route the power-adapter-port cable through the routing guides on the computer base.

Postrequisites

- 1 Replace the display assembly. See "Replacing the Display Assembly" on page 56.
- 2 Replace the system board. See "Replacing the System Board" on page 45.
- 3 Replace the wireless mini-card. See "Replacing the Wireless Card" on page 33.
- 4 Replace the palm rest. See "Replacing the Palm Rest" on page 51.
- 5 Replace the keyboard. See "Replacing the Keyboard" on page 26.
- 6 Replace the base cover. See "Replacing the Base Cover" on page 29.
- 7 Replace the optical-drive assembly. See "Replacing the Optical Drive" on page 18.
- 8 Replace the hard-drive assembly. See "Replacing the Hard Drive" on page 21.
- 9 Replace the battery. See "Replacing the Battery" on page 12.

Flashing the BIOS

You may need to flash (update) the BIOS when an update is available or when you replace the system board. To flash the BIOS:

- 1 Turn on the computer.
- 2 Go to **dell.com/support**.
- 3 If you have your computer's Service Tag, type your computer's Service Tag and click **Submit**.

If you do not have your computer's service tag, click **Detect Service Tag** to allow automatic detection of your computer's service tag.



NOTE: If the Service Tag cannot be detected automatically, select your product under the product categories.

- 4 Click **Drivers and Downloads**.
- 5 In the **Operating System** drop-down, select the operating system installed on your computer.
- 6 Click **BIOS**.
- 7 Click **Download File** to download the latest version of the BIOS for your computer.
- 8 On the next page, select **Single-file download** and click **Continue**.
- 9 Save the file and once the download is complete, navigate to the folder where you saved the BIOS update file.
- 10 Double-click the BIOS update file icon and follow the instructions on the screen.