

Inspiron 17

5000 Series

Owner's Manual

Computer Model: Inspiron 17-5748
Regulatory Model: P26E
Regulatory Type: P26E001



Notes, Cautions, and Warnings



NOTE: A NOTE indicates important information that helps you make better use of your computer.



CAUTION: A CAUTION indicates either potential damage to hardware or loss of data and tells you how to avoid the problem.



WARNING: A WARNING indicates a potential for property damage, personal injury, or death.

Copyright © 2014 Dell Inc. All rights reserved. This product is protected by U.S. and international copyright and intellectual property laws. Dell™ and the Dell logo are trademarks of Dell Inc. in the United States and/or other jurisdictions. All other marks and names mentioned herein may be trademarks of their respective companies.

2014 - 04

Rev. A00

Contents

Before Working Inside Your Computer.....	9
Before You Begin	9
Safety Instructions.....	9
Recommended Tools.....	10
After Working Inside Your Computer.....	11
Removing the Battery.....	12
Procedure.....	12
Replacing the Battery.....	13
Procedure.....	13
Removing the Base Cover.....	14
Prerequisites.....	14
Procedure.....	15
Replacing the Base Cover.....	16
Procedure.....	16
Post-requisites.....	16
Removing the Optical Drive.....	17
Prerequisites.....	17
Procedure.....	17
Replacing the Optical Drive.....	19
Procedure.....	19
Post-requisites.....	19

Removing the Hard Drive	20
Prerequisites.....	20
Procedure.....	20
Replacing the Hard Drive	23
Procedure.....	23
Post-requisites.....	23
Removing the Memory Module	24
Prerequisites.....	24
Procedure.....	25
Replacing the Memory Module	26
Procedure.....	27
Post-requisites.....	27
Removing the Wireless Card	28
Prerequisites.....	28
Procedure.....	28
Replacing the Wireless Card	30
Procedure.....	30
Post-requisites.....	30
Removing the Keyboard	31
Prerequisites.....	31
Procedure.....	31
Replacing the Keyboard	34
Procedure.....	34
Folding the Keyboard Cables.....	34
Post-requisites.....	37

Removing the Palm Rest	38
Prerequisites.....	38
Procedure.....	39
Replacing the Palm Rest	43
Procedure.....	43
Post-requisites.....	43
Removing the Power-Button Board	44
Prerequisites.....	44
Procedure.....	44
Replacing the Power-Button Board	46
Procedure.....	46
Post-requisites.....	46
Removing the Touchpad	47
Prerequisites.....	47
Procedure.....	48
Replacing the Touchpad	49
Procedure.....	49
Post-requisites.....	49
Removing the Battery-Connector Board	50
Prerequisites.....	50
Procedure.....	51
Replacing the Battery-Connector Board	52
Procedure.....	52
Post-requisites.....	52

Removing the I/O Board	53
Prerequisites.....	53
Procedure.....	53
Replacing the I/O Board	55
Procedure.....	55
Post-requisites.....	55
Removing the Optical-Drive Connector Board	56
Prerequisites.....	56
Procedure.....	57
Replacing the Optical-Drive Connector Board	58
Procedure.....	58
Post-requisites.....	58
Removing the Coin-Cell Battery	59
Prerequisites.....	59
Procedure.....	59
Replacing the Coin-Cell Battery	61
Procedure.....	61
Post-requisites.....	61
Removing the Speakers	62
Prerequisites.....	62
Procedure.....	62
Replacing the Speakers	64
Procedure.....	64
Post-requisites.....	64

Removing the System Board.....	65
Prerequisites.....	65
Procedure.....	65
Replacing the System Board.....	68
Procedure.....	68
Post-requisites.....	68
Removing the Heat-Sink Assembly.....	70
Prerequisites.....	70
Procedure.....	71
Replacing the Heat-Sink Assembly.....	72
Procedure.....	72
Post-requisites.....	72
Removing the Display Assembly.....	73
Prerequisites.....	73
Procedure.....	73
Replacing the Display Assembly.....	76
Procedure.....	76
Post-requisites.....	76
Removing the Display Bezel.....	78
Prerequisites.....	78
Procedure.....	78
Replacing the Display Bezel.....	80
Procedure.....	80
Post-requisites.....	80

Removing the Camera	81
Prerequisites.....	81
Procedure.....	82
Replacing the Camera	83
Procedure.....	83
Post-requisites.....	83
Removing the Display Panel	84
Prerequisites.....	84
Procedure.....	85
Replacing the Display Panel	87
Procedure.....	87
Post-requisites.....	87
Removing the Display Back-Cover and Antenna Assembly	88
Prerequisites.....	88
Procedure.....	88
Replacing the Display Back-Cover and Antenna Assembly	90
Procedure.....	90
Post-requisite.....	90
Flashing the BIOS	91
Getting Help and Contacting Dell	92
Self-Help Resources.....	92
Contacting Dell.....	92

Before Working Inside Your Computer

 **CAUTION:** To avoid damaging the components and cards, handle them by their edges and avoid touching pins and contacts.

Before You Begin

- 1 Save and close all open files and exit all open applications.
- 2 Shut down your computer.
 - Windows 8: Move your mouse pointer to the upper-right or lower-right corner of the screen to open the charms sidebar, and then click or tap **Settings** → **Power** → **Shut down**.
 - Windows 7: Click or tap **Start**  → **Shut down** .









 **NOTE:** If you are using a different operating system, see the documentation of your operating system for shut-down instructions.

- 3 Disconnect your computer and all attached devices from their electrical outlets.
- 4 Disconnect all cables such as telephone cables, network cables and so on, from your computer.
- 5 Disconnect all attached devices and peripherals, such as keyboard, mouse, monitor, and so on, from your computer.
- 6 Remove any media card and optical disc from your computer, if applicable.

Safety Instructions

Use the following safety guidelines to protect your computer from potential damage and ensure your personal safety.

 **WARNING:** Before working inside your computer, read the safety information that shipped with your computer. For more safety best practices, see the Regulatory Compliance home page at dell.com/regulatory_compliance.

-  **WARNING:** Disconnect all power sources before opening the computer cover or panels. After you finish working inside the computer, replace all covers, panels, and screws before connecting to the power source.
-  **CAUTION:** To avoid damaging the computer, make sure that the work surface is flat and clean.
-  **CAUTION:** To avoid damaging the components and cards, handle them by their edges and avoid touching pins and contacts.
-  **CAUTION:** Only a certified service technician is authorized to remove the computer cover and access any of the components inside the computer. See the safety instructions for complete information about safety precautions, working inside your computer, and protecting against electrostatic discharge.
-  **CAUTION:** Before touching anything inside your computer, ground yourself by touching an unpainted metal surface, such as the metal at the back of the computer. While you work, periodically touch an unpainted metal surface to dissipate static electricity, which could harm internal components.
-  **CAUTION:** When you disconnect a cable, pull on its connector or on its pull-tab, not on the cable itself. Some cables have connectors with locking tabs or thumb-screws that you must disengage before disconnecting the cable. When disconnecting cables, keep them evenly aligned to avoid bending any connector pins. When connecting cables, make sure that the ports and connectors are correctly oriented and aligned.
-  **CAUTION:** To disconnect a network cable, first unplug the cable from your computer and then unplug the cable from the network device.
-  **CAUTION:** Press and eject any installed card from the media-card reader.

Recommended Tools

The procedures in this document may require the following tools:

- Philips screwdriver
- Plastic scribe

After Working Inside Your Computer



CAUTION: Leaving stray or loose screws inside your computer may severely damage your computer.

- 1 Replace all screws and make sure that no stray screws remain inside your computer.
- 2 Connect any external devices, peripherals, and cables you removed before working on your computer.
- 3 Replace any media cards, discs, and any other part(s) that you removed before working on your computer.
- 4 Connect your computer and all attached devices to their electrical outlets.
- 5 Turn on your computer.

Removing the Battery

⚠ WARNING: Before working inside your computer, read the safety information that shipped with your computer and follow the steps in [Before Working Inside Your Computer](#). After working inside your computer, follow the instructions in [After Working Inside Your Computer](#). For more safety best practices, see the Regulatory Compliance home page at dell.com/regulatory_compliance.

Procedure

- 1 Close the display and turn the computer over.
- 2 Slide the battery latches to the unlock position.

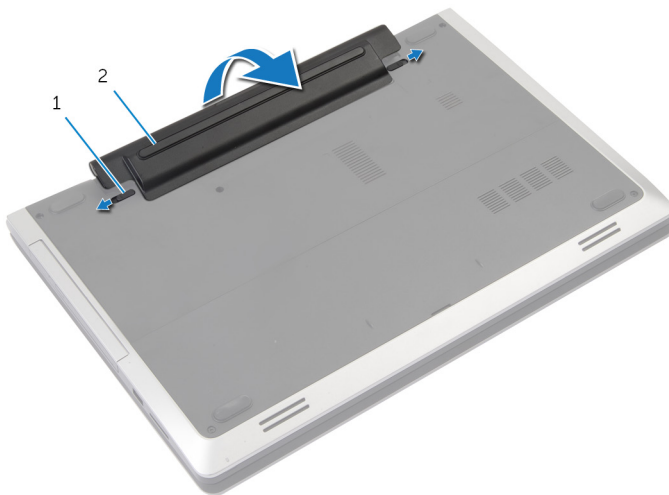

1 latches (2)

2 battery

- 3 Pry out the battery from the battery bay.
- 4 Turn the computer over and open the display as far as possible.
- 5 Press and hold the power button for 5 seconds to ground the system board.

Replacing the Battery



WARNING: Before working inside your computer, read the safety information that shipped with your computer and follow the steps in [Before Working Inside Your Computer](#). After working inside your computer, follow the instructions in [After Working Inside Your Computer](#). For more safety best practices, see the Regulatory Compliance home page at dell.com/regulatory_compliance.

Procedure

- 1 Align the tabs on the battery with the slots on the battery bay.
- 2 Snap the battery into place.

Removing the Base Cover



WARNING: Before working inside your computer, read the safety information that shipped with your computer and follow the steps in [Before Working Inside Your Computer](#). After working inside your computer, follow the instructions in [After Working Inside Your Computer](#). For more safety best practices, see the Regulatory Compliance home page at dell.com/regulatory_compliance.

Prerequisites

Remove the [battery](#).

Procedure

- 1 Remove the screws that secure the base cover to the computer base.

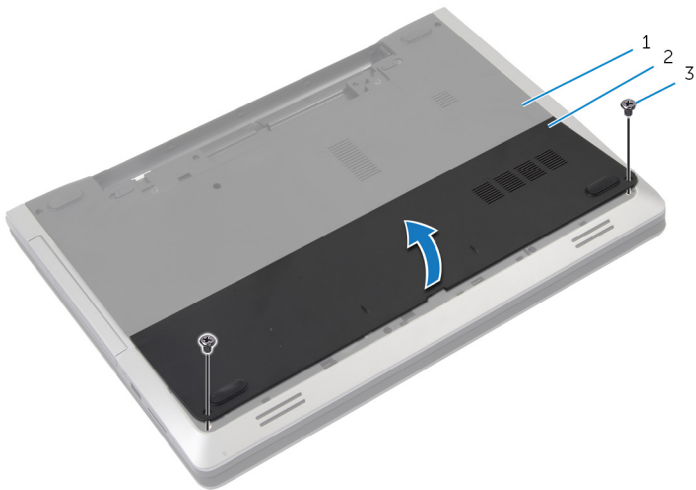

- | | | | |
|---|---------------|---|------------|
| 1 | computer base | 2 | base cover |
| 3 | screws (2) | | |

- 2 Using your fingertips, pry the base cover and lift it off the computer base.

Replacing the Base Cover



WARNING: Before working inside your computer, read the safety information that shipped with your computer and follow the steps in [Before Working Inside Your Computer](#). After working inside your computer, follow the instructions in [After Working Inside Your Computer](#). For more safety best practices, see the Regulatory Compliance home page at dell.com/regulatory_compliance.

Procedure

- 1 Slide the tabs on the base cover into the slots on the computer base and snap the base cover into place.
- 2 Replace the screws that secure the base cover to the computer base.

Post-requisites

Replace the [battery](#).

Removing the Optical Drive

! **WARNING:** Before working inside your computer, read the safety information that shipped with your computer and follow the steps in [Before Working Inside Your Computer](#). After working inside your computer, follow the instructions in [After Working Inside Your Computer](#). For more safety best practices, see the Regulatory Compliance home page at dell.com/regulatory_compliance.

Prerequisites

Remove the [battery](#).

Procedure

- 1 Remove the screw that secures the optical-drive assembly to the computer base.
- 2 Using your fingertips, slide the optical-drive assembly out of the optical-drive bay.

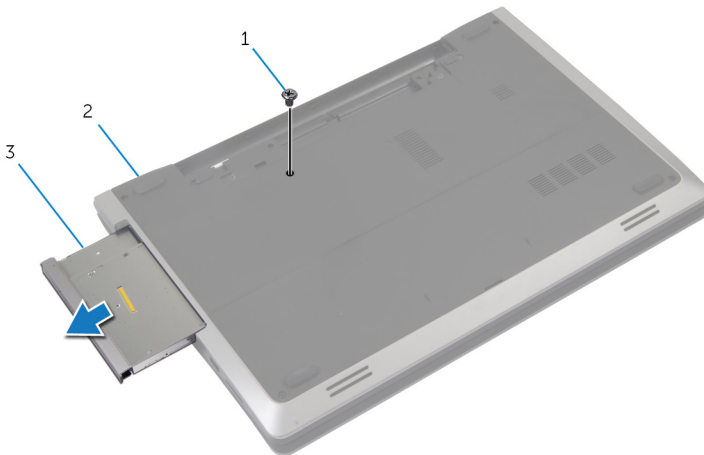

- | | | | |
|---|------------------------|---|---------------|
| 1 | screw | 2 | computer base |
| 3 | optical-drive assembly | | |

- 3 Remove the screw that secures the optical-drive bracket to the optical-drive assembly.
- 4 Remove the optical-drive bracket from the optical-drive assembly.

5 Carefully pull the optical-drive bezel and remove it from the optical drive.

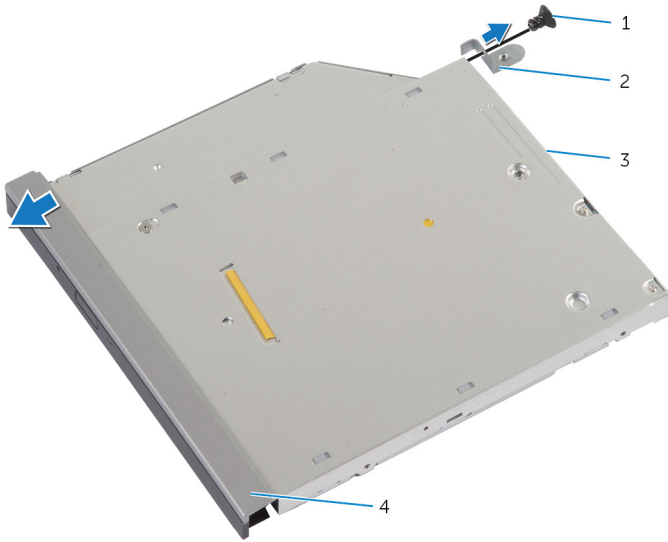

1 screw

2 optical-drive bracket

3 optical drive

4 optical-drive bezel

Replacing the Optical Drive



WARNING: Before working inside your computer, read the safety information that shipped with your computer and follow the steps in [Before Working Inside Your Computer](#). After working inside your computer, follow the instructions in [After Working Inside Your Computer](#). For more safety best practices, see the Regulatory Compliance home page at dell.com/regulatory_compliance.

Procedure

- 1 Align the tabs on the optical-drive bezel with the slots on the optical drive and snap the optical-drive bezel into place.
- 2 Align the screw hole on the optical-drive bracket with the screw hole on the optical-drive assembly.
- 3 Replace the screw that secures the optical-drive bracket to the optical-drive assembly.
- 4 Slide the optical-drive assembly into the optical-drive bay and align the screw hole on the optical-drive bracket with the screw hole on the computer base.
- 5 Replace the screw that secures the optical-drive assembly to the computer base.

Post-requisites

Replace the [battery](#).

Removing the Hard Drive

 **WARNING:** Before working inside your computer, read the safety information that shipped with your computer and follow the steps in [Before Working Inside Your Computer](#). After working inside your computer, follow the instructions in [After Working Inside Your Computer](#). For more safety best practices, see the Regulatory Compliance home page at dell.com/regulatory_compliance.

 **CAUTION:** Hard drives are fragile. Exercise care when handling the hard drive.

 **CAUTION:** To avoid data loss, do not remove the hard drive while the computer is in Sleep or On state.

Prerequisites

- 1 Remove the [battery](#).
- 2 Remove the [base cover](#).

Procedure

- 1 Remove the screw that secures the hard-drive assembly to the computer base.
- 2 Using the pull tab, slide the hard-drive assembly to disconnect it from the system board.

- 3** Lift the hard-drive assembly off the computer base.

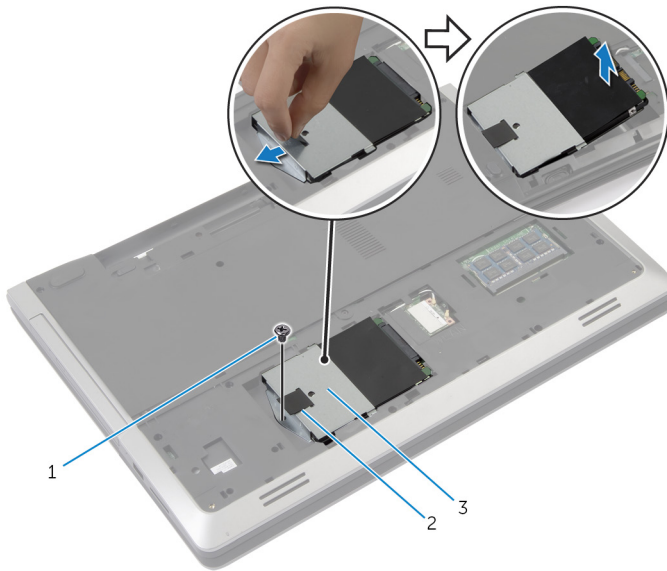

1 screw

2 pull-tab

3 hard-drive assembly

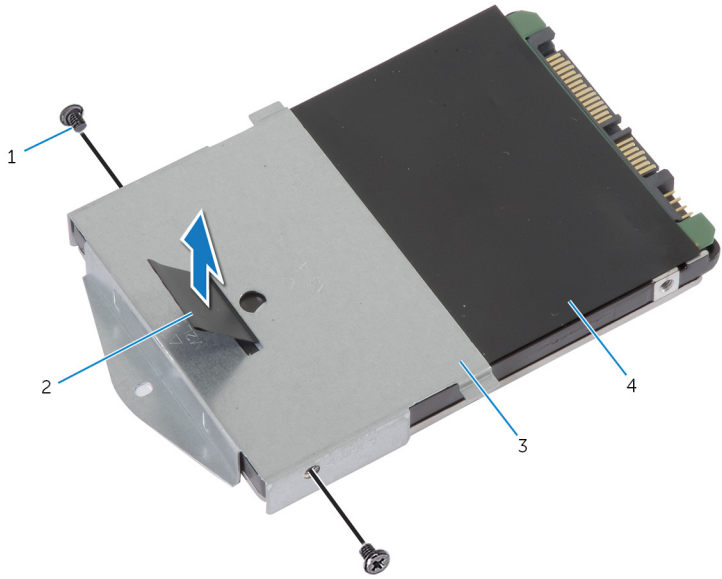

- 4** Remove the screws that secure the hard-drive bracket to the hard drive.

5 Using the pull-tab, lift the hard-drive bracket off the hard drive.



- | | | | |
|---|--------------------|---|------------|
| 1 | screws (2) | 2 | pull-tab |
| 3 | hard-drive bracket | 4 | hard drive |

Replacing the Hard Drive

-  **WARNING:** Before working inside your computer, read the safety information that shipped with your computer and follow the steps in [Before Working Inside Your Computer](#). After working inside your computer, follow the instructions in [After Working Inside Your Computer](#). For more safety best practices, see the Regulatory Compliance home page at dell.com/regulatory_compliance.
-  **CAUTION:** Hard drives are fragile. Exercise care when handling the hard drive.

Procedure

- 1 Align the screw holes on the hard-drive bracket with the screw holes on the hard drive.
- 2 Replace the screws that secure the hard-drive bracket to the hard drive.
- 3 Place the hard-drive assembly in the hard-drive bay.
- 4 Slide and connect the hard-drive assembly to the system board.
- 5 Replace the screw that secures the hard-drive assembly to the computer base.

Post-requisites

- 1 Replace the [base cover](#).
- 2 Replace the [battery](#).

Removing the Memory Module



WARNING: Before working inside your computer, read the safety information that shipped with your computer and follow the steps in [Before Working Inside Your Computer](#). After working inside your computer, follow the instructions in [After Working Inside Your Computer](#). For more safety best practices, see the Regulatory Compliance home page at dell.com/regulatory_compliance.

Prerequisites

- 1 Remove the [battery](#).
- 2 Remove the [base cover](#).

Procedure

- 1 Using your fingertips, spread apart the securing clips on each end of the memory-module slot until the memory module pops up.

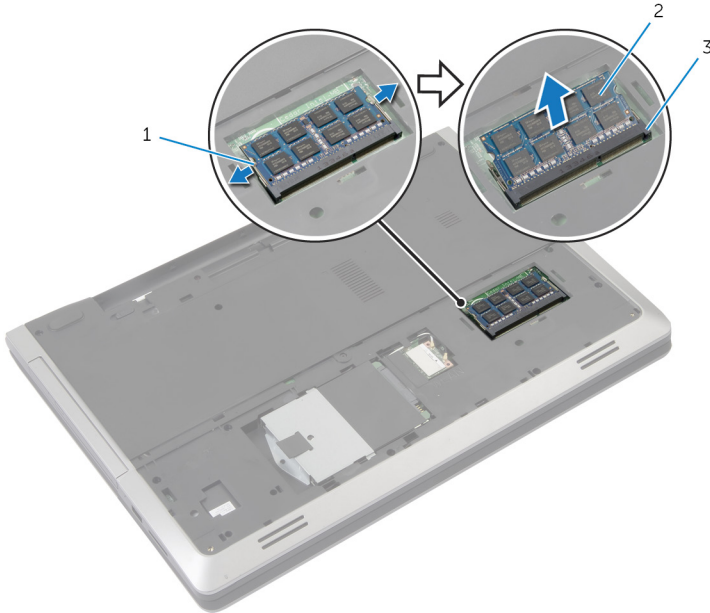

1 securing clips (2)

2 memory module

3 memory-module slot

- 2 Slide the memory module away from the memory-module slot.

Replacing the Memory Module



WARNING: Before working inside your computer, read the safety information that shipped with your computer and follow the steps in [Before Working Inside Your Computer](#). After working inside your computer, follow the instructions in [After Working Inside Your Computer](#). For more safety best practices, see the Regulatory Compliance home page at dell.com/regulatory_compliance.

Procedure

- 1 Align the notch on the memory module with the tab on the memory-module slot.
- 2 Slide the memory module into the slot at an angle, and press the memory module down until it clicks into place.

 **NOTE:** If you do not hear the click, remove the memory module and reinstall it.

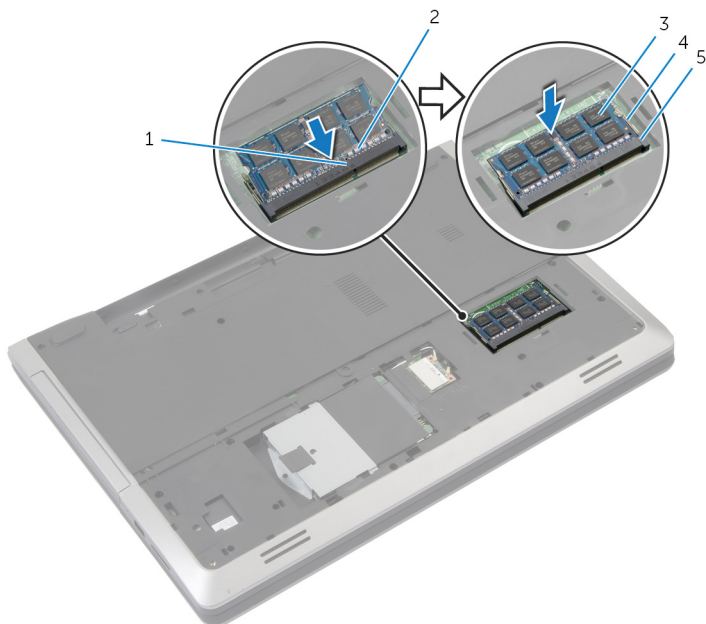

- | | | | |
|---|--------------------|---|--------------------|
| 1 | tab | 2 | notch |
| 3 | memory module | 4 | securing clips (2) |
| 5 | memory-module slot | | |

Post-requisites

- 1 Replace the [base cover](#).
- 2 Replace the [battery](#).

Removing the Wireless Card



WARNING: Before working inside your computer, read the safety information that shipped with your computer and follow the steps in [Before Working Inside Your Computer](#). After working inside your computer, follow the instructions in [After Working Inside Your Computer](#). For more safety best practices, see the Regulatory Compliance home page at dell.com/regulatory_compliance.

Prerequisites

- 1 Remove the [battery](#).
- 2 Remove the [base cover](#).

Procedure

- 1 Disconnect the antenna cables from the wireless card.
- 2 Push the securing tab to release the wireless card.

3 Slide the wireless card out of the wireless-card slot.

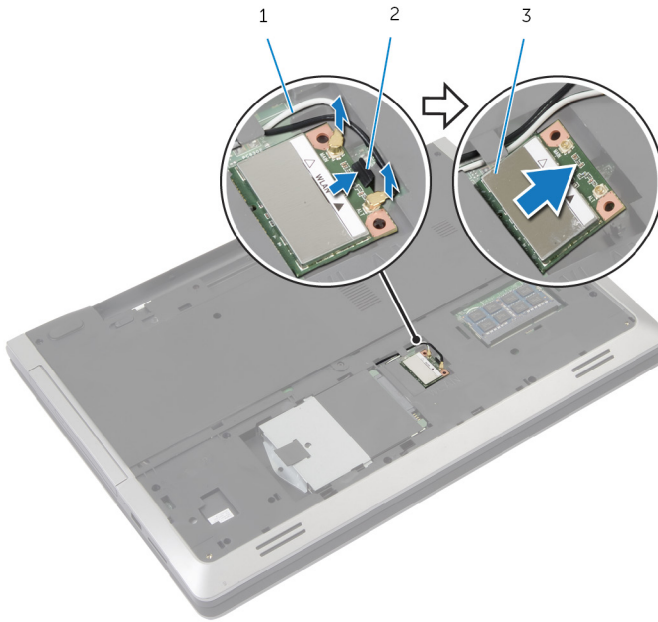

1 antenna cables (2)

2 securing tab

3 wireless card

Replacing the Wireless Card

 **WARNING:** Before working inside your computer, read the safety information that shipped with your computer and follow the steps in [Before Working Inside Your Computer](#). After working inside your computer, follow the instructions in [After Working Inside Your Computer](#). For more safety best practices, see the Regulatory Compliance home page at dell.com/regulatory_compliance.

Procedure

 **CAUTION:** To avoid damage to the wireless card, do not place any cables under it.

- 1 Align the notch on the wireless card with the tab on the wireless-card slot.
- 2 Insert the wireless card at an angle into the connector.
- 3 Push the securing tab out and secure the wireless card into position.
- 4 Connect the antenna cables to the wireless card.

The following table provides the antenna cable color schemes for the wireless card supported by your computer.

Connectors on the wireless card	Antenna-cable color schemes
Main (white triangle)	white
Auxiliary (black triangle)	black

Post-requisites

- 1 Replace the [base cover](#).
- 2 Replace the [battery](#).

Removing the Keyboard



WARNING: Before working inside your computer, read the safety information that shipped with your computer and follow the steps in [Before Working Inside Your Computer](#). After working inside your computer, follow the instructions in [After Working Inside Your Computer](#). For more safety best practices, see the Regulatory Compliance home page at dell.com/regulatory_compliance.

Prerequisites

Remove the [battery](#).

Procedure

- 1 Turn the computer over and open the display as far as possible.
- 2 Using a plastic scribe, release the tabs that secure the keyboard to the palm-rest assembly.

- Carefully turn the keyboard over and place it on the palm rest assembly.



- plastic scribe
- keyboard
- palm-rest assembly

- Lift the latches and disconnect the keyboard cable and keyboard-backlight cable from the system board.

 **NOTE:** The backlight-keyboard is optional. The keyboard-backlight cable is present only if the laptop shipped with a backlit-keyboard.

5 Lift the keyboard along with the cables, off the palm-rest assembly.

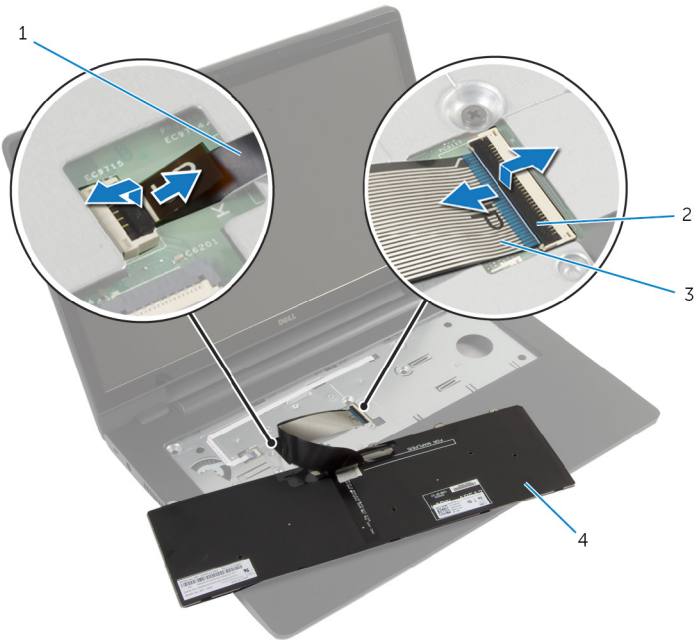

- | | | | |
|---|--------------------------|---|-------------|
| 1 | keyboard-backlight cable | 2 | latches (2) |
| 3 | keyboard cable | 4 | keyboard |

Replacing the Keyboard

 **WARNING:** Before working inside your computer, read the safety information that shipped with your computer and follow the steps in [Before Working Inside Your Computer](#). After working inside your computer, follow the instructions in [After Working Inside Your Computer](#). For more safety best practices, see the Regulatory Compliance home page at dell.com/regulatory_compliance.

Procedure

 **NOTE:** If you are installing a new keyboard, fold the cables the same way they are folded on the old keyboard. For more information, see "[Folding the Keyboard Cables](#)".

- 1 Slide the keyboard cable and keyboard-backlight cable into the system board connectors and press down the latches to secure the cables.
- 2 Turn the keyboard over, slide the tabs on the keyboard into the slots on the palm-rest assembly, and snap the keyboard into place.

Folding the Keyboard Cables

 **NOTE:** Keyboard-backlight cable is present only on a backlit-keyboard.



NOTE: The cables on the keyboard are not folded when you receive a new keyboard.

- 1 Place the keyboard on a flat and clean surface.

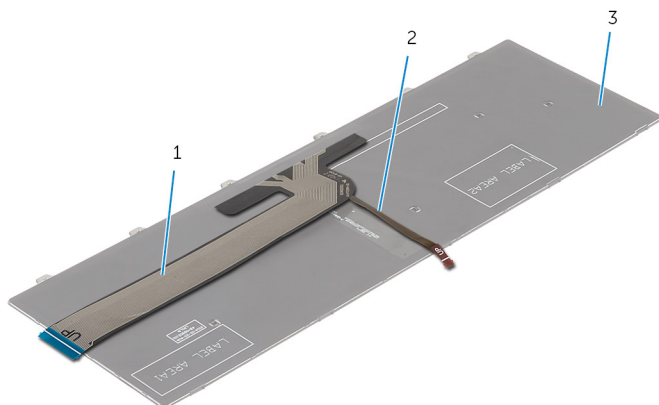

- | | | | |
|---|----------------|---|--------------------------|
| 1 | keyboard cable | 2 | keyboard-backlight cable |
| 3 | keyboard | | |



CAUTION: Do not apply excess pressure while folding the cables.

- 2 Lift the keyboard cable and gently fold the keyboard-backlight cable at the fold line.

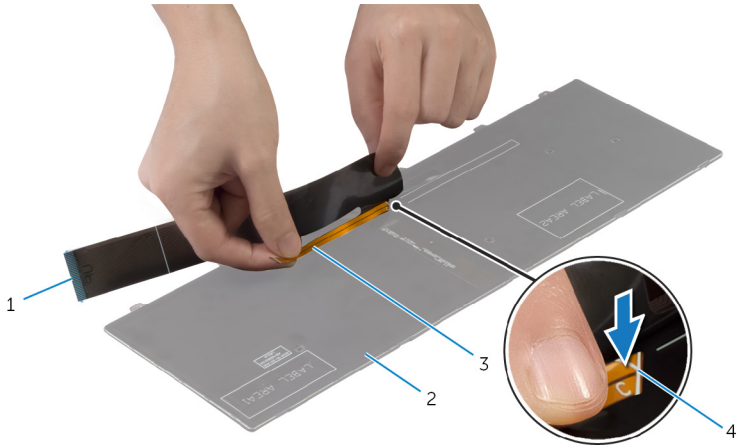

1 keyboard cable

2 keyboard

3 keyboard-backlight cable

4 fold line

- 3 Using the alignment line, gently fold the keyboard cable.

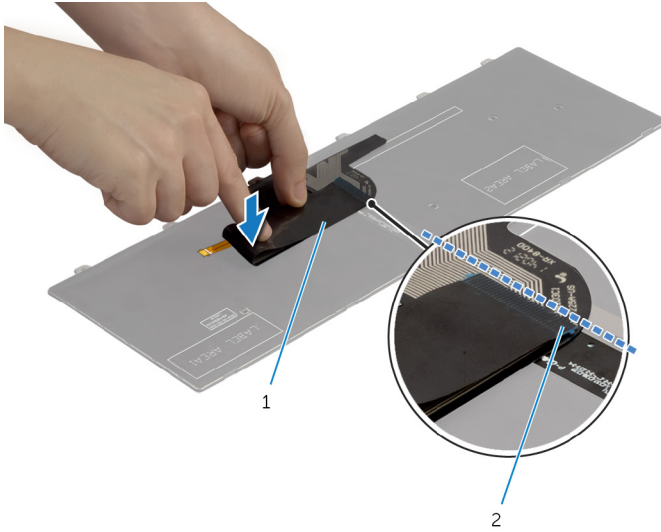

1 keyboard cable

2 alignment line

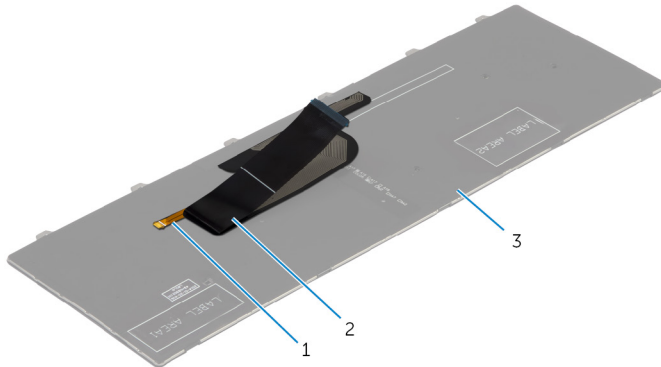

1 keyboard-backlight cable

2 keyboard cable

3 keyboard

Post-requisites

Replace the [battery](#).

Removing the Palm Rest



WARNING: Before working inside your computer, read the safety information that shipped with your computer and follow the steps in [Before Working Inside Your Computer](#). After working inside your computer, follow the instructions in [After Working Inside Your Computer](#). For more safety best practices, see the Regulatory Compliance home page at dell.com/regulatory_compliance.

Prerequisites

- 1 Remove the [battery](#).
- 2 Remove the [base cover](#).
- 3 Follow the procedure from step 1 to step 3 in removing the [hard drive](#).
- 4 Remove the [optical drive](#).
- 5 Remove the [keyboard](#).

Procedure

- 1 Remove the screws that secure the palm rest to the system board.

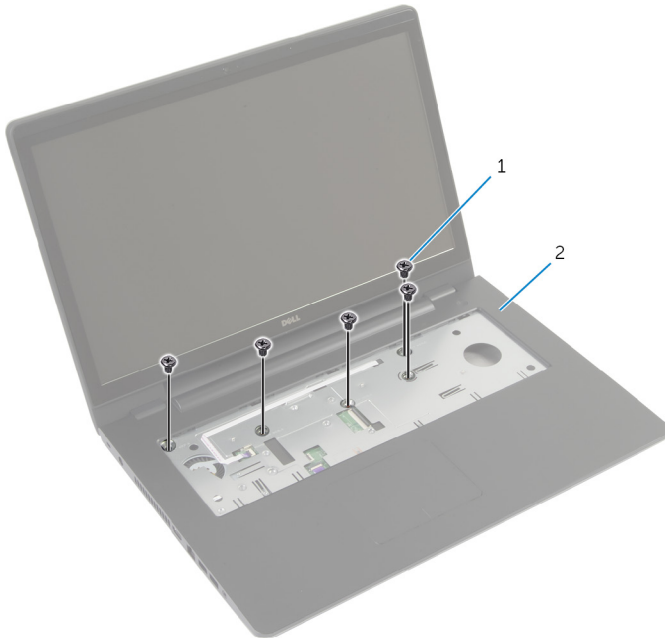

1 screws (5)

2 palm rest

- 2 Close the display and turn the computer over.

- 3** Remove the screws that secure the palm rest to the computer base.

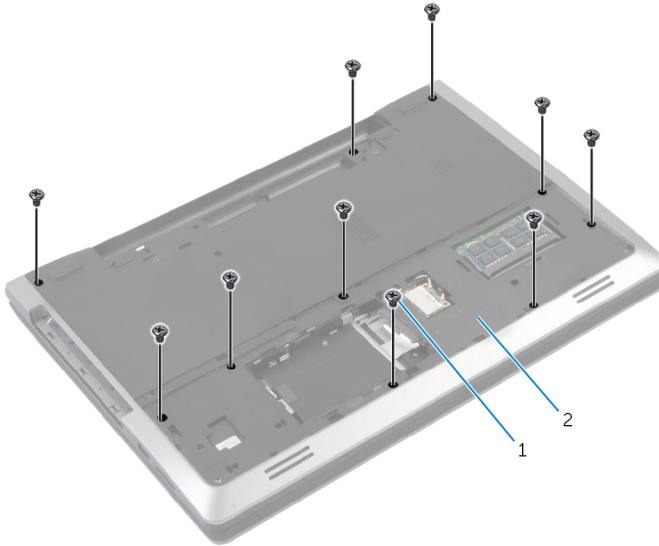

1 screws (10)

2 computer base

- 4** Turn the computer over and open the display as far as possible.

- 5 Lift the connector latches and disconnect the power-button board cable and the touchpad cable from the system board.

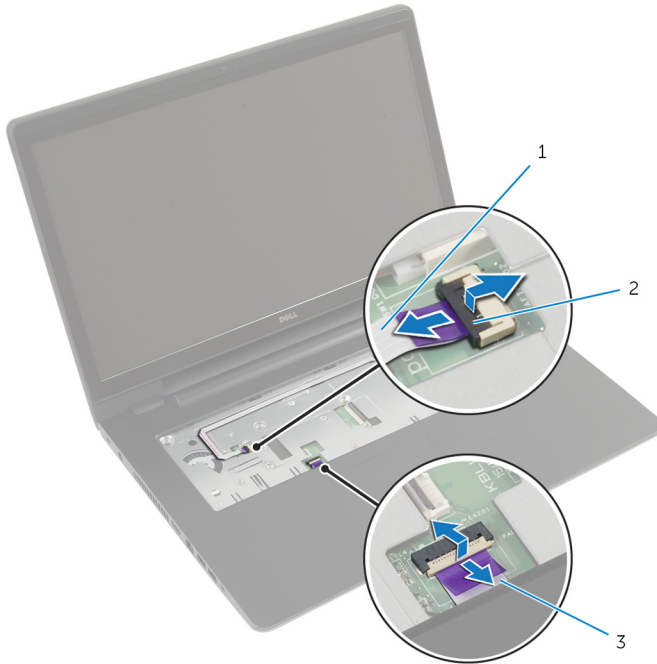

- 1 power-button board cable 2 connector latches (2)
3 touchpad cable

- 6 Using a plastic scribe, gently lift and release the tabs on the palm rest from the slots on the computer base.



1 plastic scribe

2 palm rest

- 7 Lift the palm rest away from the display assembly.

Replacing the Palm Rest



WARNING: Before working inside your computer, read the safety information that shipped with your computer and follow the steps in [Before Working Inside Your Computer](#). After working inside your computer, follow the instructions in [After Working Inside Your Computer](#). For more safety best practices, see the Regulatory Compliance home page at dell.com/regulatory_compliance.

Procedure

- 1 Align the tabs on the palm rest with the slots on the computer base and snap the palm rest into place.
- 2 Replace the screws that secure the palm rest to the system board.
- 3 Slide the touchpad cable and the power-button board cable into the system-board connectors and press down on the connector latches to secure the cables.
- 4 Close the display and turn the computer over.
- 5 Replace the screws that secure the palm rest to the computer base.

Post-requisites

- 1 Replace the [keyboard](#).
- 2 Replace the [optical drive](#).
- 3 Follow the procedures from step 3 to step 5 in replacing the [hard drive](#).
- 4 Replace the [base cover](#).
- 5 Replace the [battery](#).

Removing the Power-Button Board



WARNING: Before working inside your computer, read the safety information that shipped with your computer and follow the steps in [Before Working Inside Your Computer](#). After working inside your computer, follow the instructions in [After Working Inside Your Computer](#). For more safety best practices, see the Regulatory Compliance home page at dell.com/regulatory_compliance.

Prerequisites

- 1 Remove the [battery](#).
- 2 Remove the [base cover](#).
- 3 Follow the procedure from step 1 to step 3 in removing the [hard drive](#).
- 4 Follow the procedure from step 1 to step 2 in removing the [optical drive](#).
- 5 Remove the [keyboard](#).
- 6 Remove the [palm rest](#).

Procedure

- 1 Peel off the power-button board cable from the palm rest.
- 2 Turn the palm-rest assembly over and place it on a clean and flat surface.
- 3 Remove the power-button board cable through the slot on the palm rest assembly.
- 4 Remove the screw that secures the power-button board to the palm rest.
- 5 Note the power-button board cable routing and peel it off the palm rest.

- 6 Lift the power-button board at an angle and remove it from the palm rest.

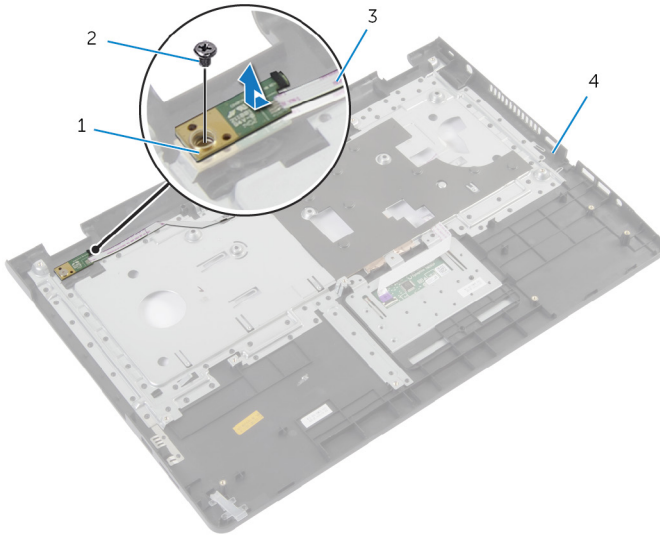

- | | | | |
|---|--------------------------|---|-----------|
| 1 | power-button board | 2 | screw |
| 3 | power-button board cable | 4 | palm rest |

Replacing the Power-Button Board



WARNING: Before working inside your computer, read the safety information that shipped with your computer and follow the steps in [Before Working Inside Your Computer](#). After working inside your computer, follow the instructions in [After Working Inside Your Computer](#). For more safety best practices, see the Regulatory Compliance home page at dell.com/regulatory_compliance.

Procedure

- 1 Align the screw hole on the power-button board with the screw hole on the palm rest.
- 2 Replace the screw that secures the power-button board to the palm rest.
- 3 Adhere the power-button board cable to the palm-rest assembly.
- 4 Slide the power-button board cable through the slot on the palm-rest assembly.
- 5 Turn the palm-rest assembly over.

Post-requisites

- 1 Replace the [palm rest](#).
- 2 Replace the [keyboard](#).
- 3 Follow the procedure from step 3 to step 5 in replacing the [hard drive](#).
- 4 Replace the [base cover](#).
- 5 Replace the [battery](#).

Removing the Touchpad



WARNING: Before working inside your computer, read the safety information that shipped with your computer and follow the steps in [Before Working Inside Your Computer](#). After working inside your computer, follow the instructions in [After Working Inside Your Computer](#). For more safety best practices, see the Regulatory Compliance home page at dell.com/regulatory_compliance.

Prerequisites

- 1 Remove the [battery](#).
- 2 Remove the [base cover](#).
- 3 Follow the procedures from step 1 to step 3 in removing the [hard drive](#).
- 4 Follow the procedures from step 1 to step 2 in removing the [optical drive](#).
- 5 Remove the [keyboard](#).
- 6 Remove the [palm rest](#).

Procedure

- 1 Lift the connector latch and disconnect the touchpad cable from the touchpad.
- 2 Remove the screws that secure the touchpad to the palm rest.

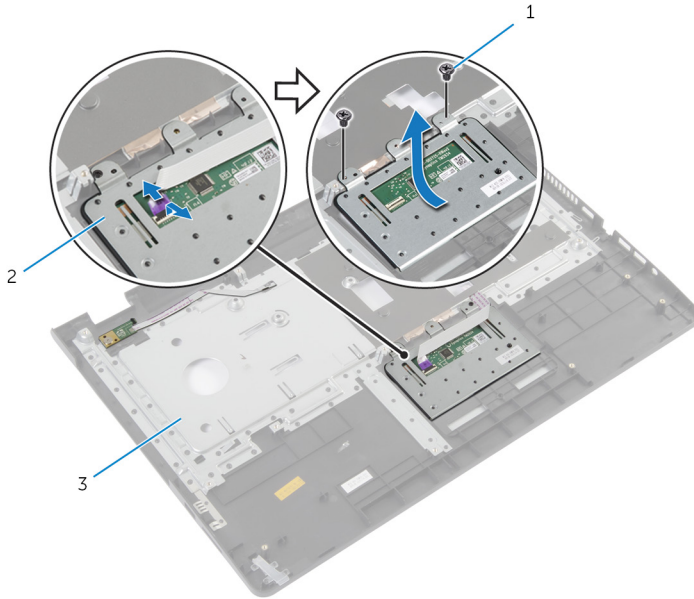

- | | | | |
|---|------------|---|----------|
| 1 | screws (2) | 2 | touchpad |
| 3 | palm rest | | |

- 3 Lift the touchpad away from the palm rest.

Replacing the Touchpad



WARNING: Before working inside your computer, read the safety information that shipped with your computer and follow the steps in [Before Working Inside Your Computer](#). After working inside your computer, follow the instructions in [After Working Inside Your Computer](#). For more safety best practices, see the Regulatory Compliance home page at dell.com/regulatory_compliance.

Procedure

- 1 Align the screw holes on the touchpad with the screw holes on the palm rest.
- 2 Replace the screws that secure the touchpad to the palm rest.
- 3 Slide the touchpad cable into the connector on the touchpad and press down the latch to secure it.

Post-requisites

- 1 Replace the [palm rest](#).
- 2 Replace the [keyboard](#).
- 3 Follow the procedures from step 4 to step 5 in replacing the [optical drive](#).
- 4 Follow the procedures from step 3 to step 5 in replacing the [hard drive](#).
- 5 Replace the [base cover](#).
- 6 Replace the [battery](#).

Removing the Battery-Connector Board

 **WARNING:** Before working inside your computer, read the safety information that shipped with your computer and follow the steps in [Before Working Inside Your Computer](#). After working inside your computer, follow the instructions in [After Working Inside Your Computer](#). For more safety best practices, see the Regulatory Compliance home page at dell.com/regulatory_compliance.

Prerequisites

- 1 Remove the [battery](#).
- 2 Remove the [base cover](#).
- 3 Follow the procedures from step 1 to step 3 in removing the [hard drive](#).
- 4 Follow the procedures from step 1 to step 2 in removing the [optical drive](#).
- 5 Remove the [keyboard](#).
- 6 Remove the [palm rest](#).

Procedure

- 1 Remove the screws that secure the battery-connector board to the computer base.

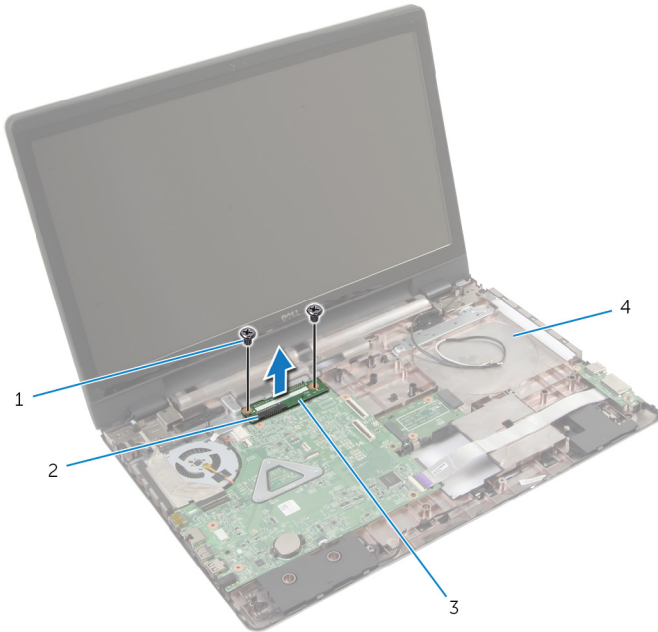

- | | | | |
|---|-------------------------|---|-----------------|
| 1 | screws (2) | 2 | connector latch |
| 3 | battery-connector board | 4 | computer base |

- 2 Carefully lift the battery-connector board to disconnect it from the system board.

Replacing the Battery-Connector Board

 **WARNING:** Before working inside your computer, read the safety information that shipped with your computer and follow the steps in [Before Working Inside Your Computer](#). After working inside your computer, follow the instructions in [After Working Inside Your Computer](#). For more safety best practices, see the Regulatory Compliance home page at dell.com/regulatory_compliance.

Procedure

- 1 Align the screw holes on the battery-connector board with the screw holes on the computer base.
- 2 Press the battery-connector board down into position.
- 3 Replace the screws that secure the battery-connector board to the computer base.

Post-requisites

- 1 Replace the [palm rest](#).
- 2 Replace the [keyboard](#).
- 3 Follow the procedures from step 4 to step 5 in replacing the [optical drive](#).
- 4 Follow the procedures from step 3 to step 5 in replacing the [hard drive](#).
- 5 Replace the [base cover](#).
- 6 Replace the [battery](#).

Removing the I/O Board



WARNING: Before working inside your computer, read the safety information that shipped with your computer and follow the steps in [Before Working Inside Your Computer](#). After working inside your computer, follow the instructions in [After Working Inside Your Computer](#). For more safety best practices, see the Regulatory Compliance home page at dell.com/regulatory_compliance.

Prerequisites

- 1 Remove the [battery](#).
- 2 Remove the [base cover](#).
- 3 Follow the procedures from step 1 to step 3 in removing the [hard drive](#).
- 4 Follow the procedures from step 1 to step 2 in removing the [optical drive](#).
- 5 Remove the [keyboard](#).
- 6 Remove the [palm rest](#).

Procedure

- 1 Remove the screw that secures the I/O board to the computer base.
- 2 Carefully lift the I/O board and turn it over.
- 3 Lift the connector latch and using the pull tab, disconnect the I/O-board cable from the I/O board.

4 Lift the I/O board away from the computer base.

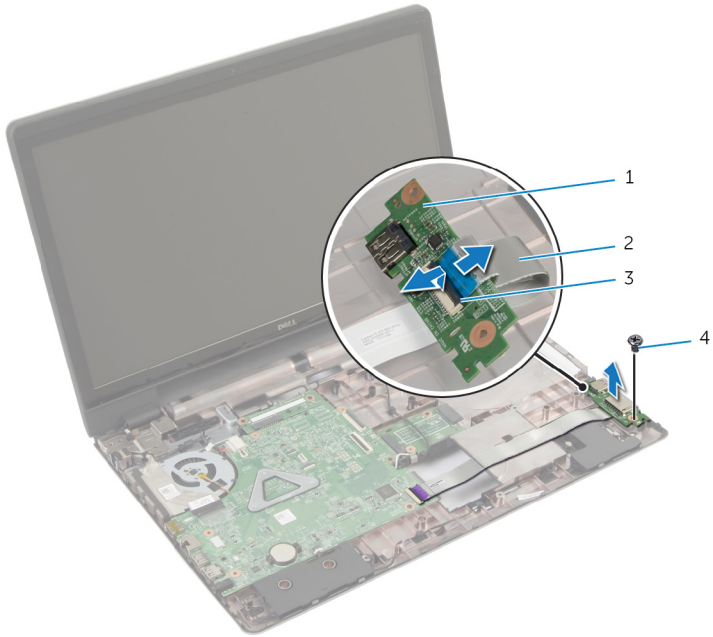

1 I/O board
3 connector latch

2 I/O-board cable
4 screw

Replacing the I/O Board



WARNING: Before working inside your computer, read the safety information that shipped with your computer and follow the steps in [Before Working Inside Your Computer](#). After working inside your computer, follow the instructions in [After Working Inside Your Computer](#). For more safety best practices, see the Regulatory Compliance home page at dell.com/regulatory_compliance.

Procedure

- 1 Slide the I/O-board cable into the connector on the I/O board and press down the latch to secure it.
- 2 Turn the I/O board over and align the screw holes on the I/O board with the screw holes on the computer base.
- 3 Replace the screw that secures the I/O board to the computer base.

Post-requisites

- 1 Replace the [palm rest](#).
- 2 Replace the [keyboard](#).
- 3 Follow the procedures from step 4 to step 5 in replacing the [optical drive](#).
- 4 Follow the procedures from step 3 to step 5 in replacing the [hard drive](#).
- 5 Replace the [base cover](#).
- 6 Replace the [battery](#).

Removing the Optical-Drive Connector Board

 **WARNING:** Before working inside your computer, read the safety information that shipped with your computer and follow the steps in [Before Working Inside Your Computer](#). After working inside your computer, follow the instructions in [After Working Inside Your Computer](#). For more safety best practices, see the Regulatory Compliance home page at dell.com/regulatory_compliance.

Prerequisites

- 1 Remove the [battery](#).
- 2 Remove the [base cover](#).
- 3 Follow the procedure from step 1 to step 3 in removing [hard drive](#).
- 4 Remove the [optical drive](#).
- 5 Remove the [wireless card](#).
- 6 Remove the [keyboard](#).
- 7 Remove the [palm rest](#).

Procedure

- 1 Remove the screw that secures the optical-drive connector board to the computer base.

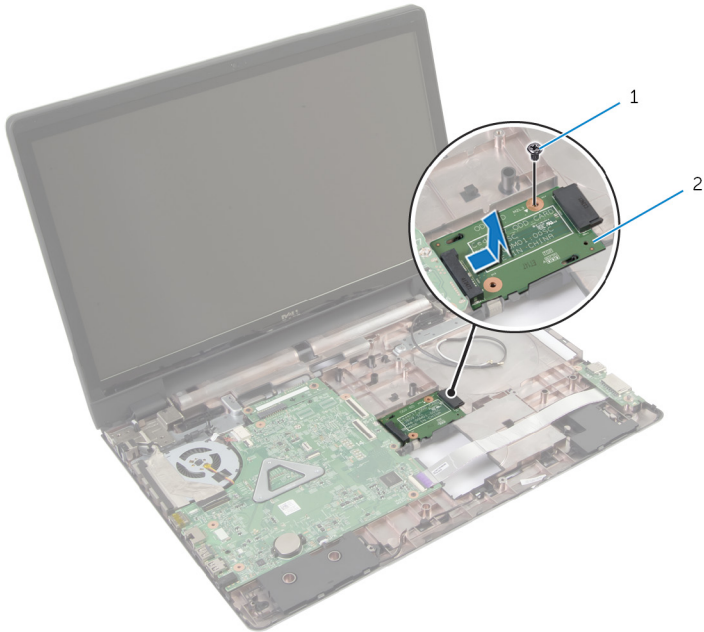

1 screw

2 optical-drive connector board

- 2 Slide and lift the optical-drive connector board away from the computer base.

Replacing the Optical-Drive Connector Board

 **WARNING:** Before working inside your computer, read the safety information that shipped with your computer and follow the steps in [Before Working Inside Your Computer](#). After working inside your computer, follow the instructions in [After Working Inside Your Computer](#). For more safety best practices, see the Regulatory Compliance home page at dell.com/regulatory_compliance.



Procedure

- 1 Slide and connect the optical-drive connector board to the system board.
- 2 Replace the screw that secures the optical-drive connector board to the computer base.

Post-requisites

- 1 Replace the [palm rest](#).
- 2 Replace the [keyboard](#).
- 3 Replace the [wireless card](#).
- 4 Follow the procedures from step 3 to step 5 in replacing the [hard drive](#).
- 5 Replace the [optical drive](#)
- 6 Replace the [base cover](#).
- 7 Replace the [battery](#).

Removing the Coin-Cell Battery

-  **WARNING:** Before working inside your computer, read the safety information that shipped with your computer and follow the steps in [Before Working Inside Your Computer](#). After working inside your computer, follow the instructions in [After Working Inside Your Computer](#). For more safety best practices, see the Regulatory Compliance home page at dell.com/regulatory_compliance.
-  **CAUTION:** Removing the coin-cell battery resets the BIOS settings to default. It is recommended that you note the BIOS settings before removing the coin-cell battery.

Prerequisites

- 1 Remove the [battery](#).
- 2 Remove the [base cover](#).
- 3 Follow the procedures from step 1 to step 3 in removing the [hard drive](#).
- 4 Follow the procedures from step 1 to step 2 in removing the [optical drive](#).
- 5 Remove the [keyboard](#).
- 6 Remove the [palm rest](#).

Procedure

Using a plastic scribe, gently pry the coin-cell battery out of the battery socket on the system board.

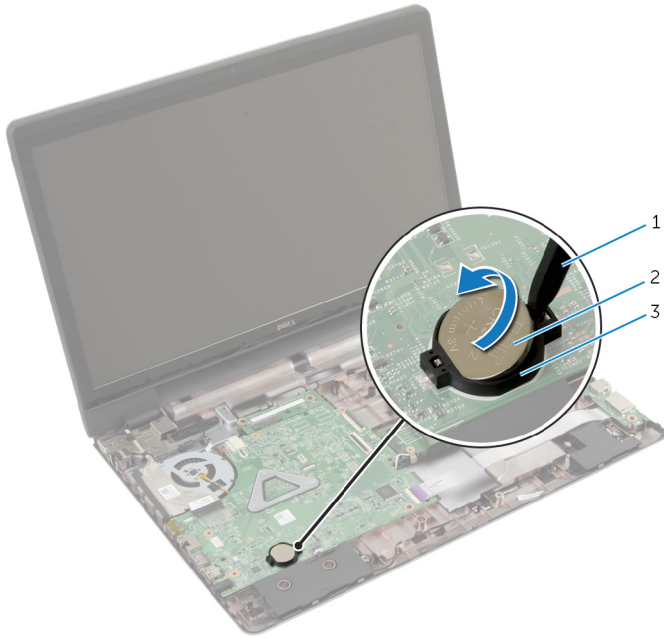

- 1 plastic scribe
- 3 battery socket

- 2 coin-cell battery

Replacing the Coin-Cell Battery



WARNING: Before working inside your computer, read the safety information that shipped with your computer and follow the steps in [Before Working Inside Your Computer](#). After working inside your computer, follow the instructions in [After Working Inside Your Computer](#). For more safety best practices, see the Regulatory Compliance home page at dell.com/regulatory_compliance.

Procedure

With the positive-side facing up, snap the coin-cell battery into the battery socket on the system board.

Post-requisites

- 1 Replace the [palm rest](#).
- 2 Replace the [keyboard](#).
- 3 Follow the procedures from step 4 to step 5 in replacing the [optical drive](#).
- 4 Follow the procedures from step 3 to step 5 in replacing the [hard drive](#).
- 5 Replace the [battery](#).
- 6 Replace the [base cover](#).

Removing the Speakers



WARNING: Before working inside your computer, read the safety information that shipped with your computer and follow the steps in [Before Working Inside Your Computer](#). After working inside your computer, follow the instructions in [After Working Inside Your Computer](#). For more safety best practices, see the Regulatory Compliance home page at dell.com/regulatory_compliance.

Prerequisites

- 1 Remove the [battery](#).
- 2 Remove the [base cover](#).
- 3 Follow the procedures from step 1 to step 3 in removing the [hard drive](#).
- 4 Follow the procedures from step 1 to step 2 in removing the [optical drive](#).
- 5 Remove the [keyboard](#).
- 6 Remove the [palm rest](#).
- 7 Remove the [I/O board](#).

Procedure

- 1 Disconnect the speaker cable from the system board.
- 2 Note the speaker-cable routing and remove the cable from the routing guides on the computer base.

3 Lift the speakers, along with the speaker cable, off the computer base.

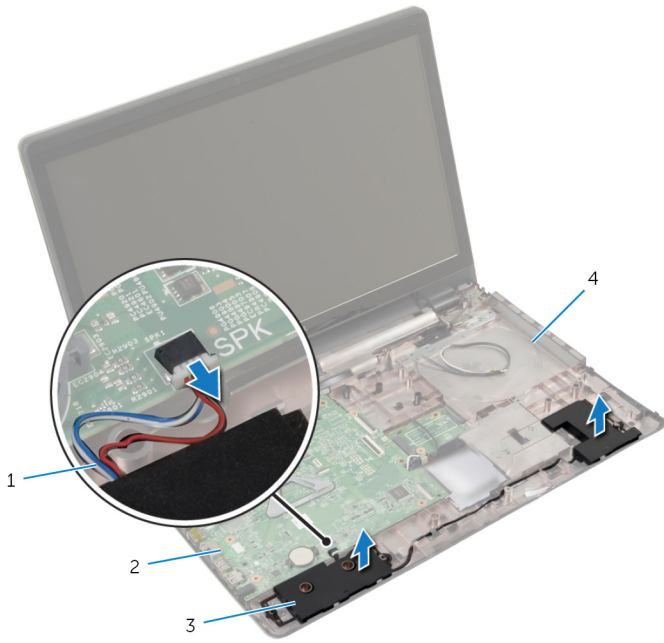

- 1 speaker cable
- 3 speakers (2)

- 2 system board
- 4 computer base

Replacing the Speakers



WARNING: Before working inside your computer, read the safety information that shipped with your computer and follow the steps in [Before Working Inside Your Computer](#). After working inside your computer, follow the instructions in [After Working Inside Your Computer](#). For more safety best practices, see the Regulatory Compliance home page at dell.com/regulatory_compliance.

Procedure

- 1 Use the alignment posts on the computer base to place the speakers in position.
- 2 Route the speaker cable through the routing guides on the computer base.
- 3 Connect the speaker cable to the system board.

Post-requisites

- 1 Replace the [I/O board](#).
- 2 Replace the [palm rest](#).
- 3 Replace the [keyboard](#).
- 4 Follow the procedure from step 3 to step 5 in replacing the [hard drive](#).
- 5 Follow the procedures from step 4 to step 5 in replacing the [optical drive](#).
- 6 Replace the [base cover](#).
- 7 Replace the [battery](#).

Removing the System Board



WARNING: Before working inside your computer, read the safety information that shipped with your computer and follow the steps in [Before Working Inside Your Computer](#). After working inside your computer, follow the instructions in [After Working Inside Your Computer](#). For more safety best practices, see the Regulatory Compliance home page at dell.com/regulatory_compliance.



NOTE: Your computer's Service Tag is stored in the system board. You must enter the Service Tag in the system setup after you replace the system board.



NOTE: Replacing the system board removes any changes you have made to the BIOS using System Setup. You must make the desired changes again after you replace the system board.



NOTE: Before disconnecting the cables from the system board, note the location of the connectors so that you can reconnect them correctly after you replace the system board.

Prerequisites

- 1 Remove the [battery](#).
- 2 Remove the [base cover](#).
- 3 Remove the [memory module](#).
- 4 Follow the procedure from step 1 to step 3 in removing the [hard drive](#).
- 5 Follow the procedure from step 1 to step 2 in removing the [optical drive](#).
- 6 Remove the [wireless card](#).
- 7 Remove the [keyboard](#).
- 8 Remove the [palm rest](#).
- 9 Remove the [battery-connector board](#).
- 10 Remove the [optical-drive connector board](#).

Procedure

- 1 Close the display and turn the computer over.
- 2 Remove the antenna cables from the routing guides on the computer base.
- 3 Slide the antenna cables through the slot on the computer base.

- 4 Turn the computer over and open the display as far as possible.
- 5 Peel off the tape that secures the display cable to the system-board assembly.
- 6 Lift the connector latches and disconnect the display cable and I/O-board cable from the system board.
- 7 Peel off the display cable from the fan.
- 8 Disconnect the power-adaptor port cable and speaker cable from the system board.

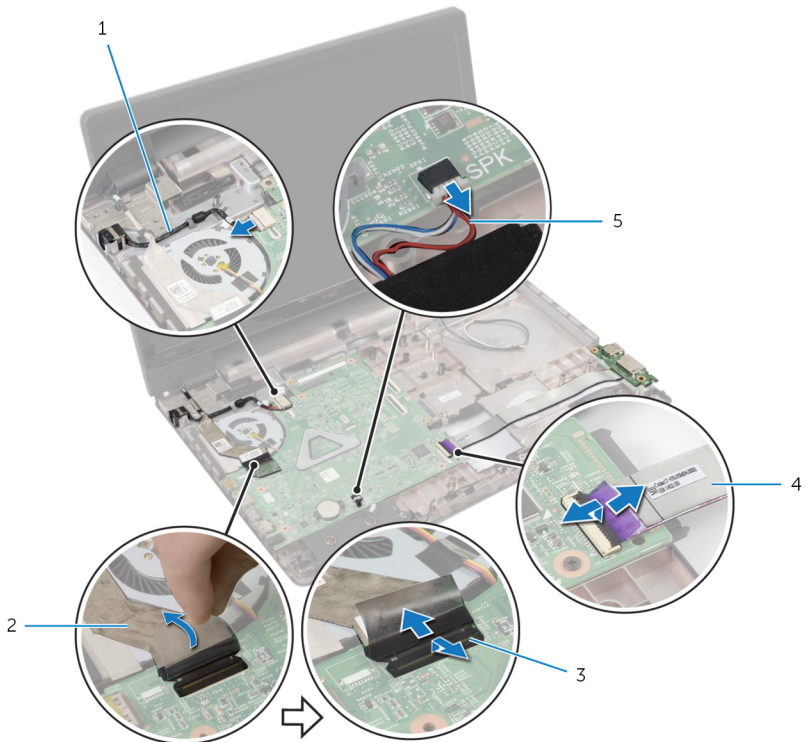

- | | | | |
|---|--------------------------|---|-----------------|
| 1 | power-adaptor port cable | 2 | display cable |
| 3 | latches (3) | 4 | I/O-board cable |
| 5 | speaker cable | | |

- 9 Remove the screws that secure the system-board assembly to the computer base.

10 Lift the system-board assembly off the computer base.

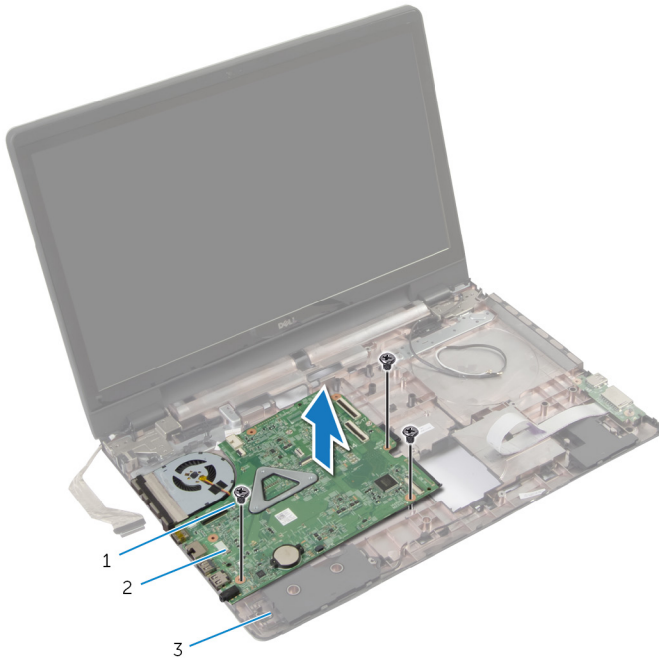

1 screws (3)

2 system-board assembly

3 computer base

11 Remove the [heatsink-sink assembly](#).

Replacing the System Board



WARNING: Before working inside your computer, read the safety information that shipped with your computer and follow the steps in [Before Working Inside Your Computer](#). After working inside your computer, follow the instructions in [After Working Inside Your Computer](#). For more safety best practices, see the Regulatory Compliance home page at dell.com/regulatory_compliance.



NOTE: Your computer's Service Tag is stored in the system board. You must enter the Service Tag in the system setup after you replace the system board.

Procedure



- 1 Replace the [heat-sink assembly](#).
- 2 Align the screw holes on the system-board assembly with the screw holes on the computer base.
- 3 Replace the screws that secure the system-board assembly to the computer base.
- 4 Connect the power-adaptor port cable and speaker cable to the system board.
- 5 Adhere the display cable to the fan.
- 6 Slide the display cable and I/O-board cable into the respective connectors and press down the latches to secure the cables.
- 7 Adhere the tape that secures the display cable to the system board.
- 8 Slide the antenna cables through the slot on the computer base.
- 9 Close the display and turn the computer over.
- 10 Route the antenna cables on the computer base.

Post-requisites

- 1 Replace the [optical-drive connector board](#).
- 2 Replace the [battery-connector board](#).
- 3 Replace the [palm rest](#).
- 4 Replace the [keyboard](#).
- 5 Replace the [wireless card](#).
- 6 Follow the procedure from step 4 to step 5 in replacing the [optical drive](#).

- 7** Follow the procedure from step 3 to step 5 in replacing the [hard drive](#).
- 8** Replace the [memory module](#).
- 9** Replace the [base cover](#).
- 10** Replace the [battery](#).

Removing the Heat-Sink Assembly

-  **WARNING:** Before working inside your computer, read the safety information that shipped with your computer and follow the steps in [Before Working Inside Your Computer](#). After working inside your computer, follow the instructions in [After Working Inside Your Computer](#). For more safety best practices, see the Regulatory Compliance home page at dell.com/regulatory_compliance.
-  **WARNING:** The heat sink may become hot during normal operation. Allow sufficient time for the heat sink to cool before you touch it.
-  **CAUTION:** To ensure maximum cooling for the processor, do not touch the heat transfer areas on the heat sink. The oils in your skin can reduce the heat transfer capability of the thermal grease.

Prerequisites

- 1 Remove the [battery](#).
- 2 Remove the [base cover](#).
- 3 Remove the [wireless card](#).
- 4 Remove the [memory module](#).
- 5 Follow the procedure from step 1 to step 2 in removing the [optical drive](#).
- 6 Follow the procedure from step 1 to step 3 in removing the [hard drive](#).
- 7 Remove the [keyboard](#).
- 8 Remove the [palm rest](#).
- 9 Remove the [battery-connector board](#).
- 10 Remove the [optical-drive connector board](#).
- 11 Follow the procedure from step 1 to step 10 in removing the [system board](#).

Procedure

- 1 Turn the system-board assembly over and place it on a flat and clean surface.
- 2 In sequential order (indicated on the heat sink), loosen the captive screws that secure the heat-sink assembly to the system board.

 **NOTE:** The appearance of the heat sink and the number of screws will vary depending on the configuration you ordered.

- 3 Disconnect the fan cable from the system board.
- 4 Lift the heat-sink assembly off the system board.

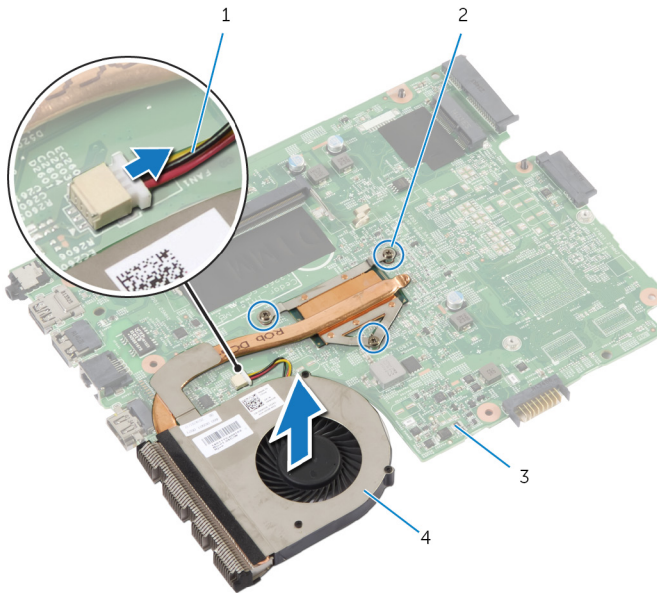

- | | | | |
|---|--------------|---|--------------------|
| 1 | fan cable | 2 | captive screws (3) |
| 3 | system board | 4 | heat-sink assembly |

Replacing the Heat-Sink Assembly

 **WARNING:** Before working inside your computer, read the safety information that shipped with your computer and follow the steps in [Before Working Inside Your Computer](#). After working inside your computer, follow the instructions in [After Working Inside Your Computer](#). For more safety best practices, see the Regulatory Compliance home page at dell.com/regulatory_compliance.

 **CAUTION:** Incorrect alignment of the heat sink can cause damage to the system board and processor.

Procedure

- 1 Align the screw holes on the heat-sink assembly with the screw holes on the system board.
- 2 In sequential order (indicated on the heat sink), tighten the captive screws that secure the heat-sink assembly to the system board.
- 3 Connect the fan cable to the system board.
- 4 Turn the system board over.

Post-requisites

- 1 Follow the procedures from step 2 to step 10 in replacing the [system board](#).
- 2 Replace the [optical-drive connector board](#).
- 3 Replace the [battery-connector board](#).
- 4 Replace the [palm rest](#).
- 5 Replace the [keyboard](#).
- 6 Follow the procedures from step 3 to step 5 in replacing the [hard drive](#).
- 7 Follow the procedures from step 4 to step 5 in replacing the [optical drive](#).
- 8 Replace the [memory module](#).
- 9 Replace the [wireless card](#).
- 10 Replace the [base cover](#).
- 11 Replace the [battery](#).

Removing the Display Assembly

 **WARNING:** Before working inside your computer, read the safety information that shipped with your computer and follow the steps in [Before Working Inside Your Computer](#). After working inside your computer, follow the instructions in [After Working Inside Your Computer](#). For more safety best practices, see the Regulatory Compliance home page at dell.com/regulatory_compliance.

Prerequisites

 **NOTE:** These instructions are applicable only for laptops with non-touchscreen display.

- 1 Remove the [battery](#).
- 2 Remove the [base cover](#).
- 3 Follow the procedures from step 1 to step 3 in removing the [hard drive](#).
- 4 Follow the procedures from step 1 to step 2 in removing the [optical drive](#).
- 5 Remove the [keyboard](#).
- 6 Remove the [palm rest](#).

Procedure

- 1 Close the display and turn the computer over.
- 2 Disconnect the antenna cables from the wireless card.
- 3 Remove the antenna cables from the routing guides on the computer base.
- 4 Slide the antenna cables through the slot on the computer base.
- 5 Turn the computer over and open the display as far as possible.
- 6 Peel off the tape that secures the display cable to the system board.

- 7** Lift the connector latch and disconnect the display cable from the system board.

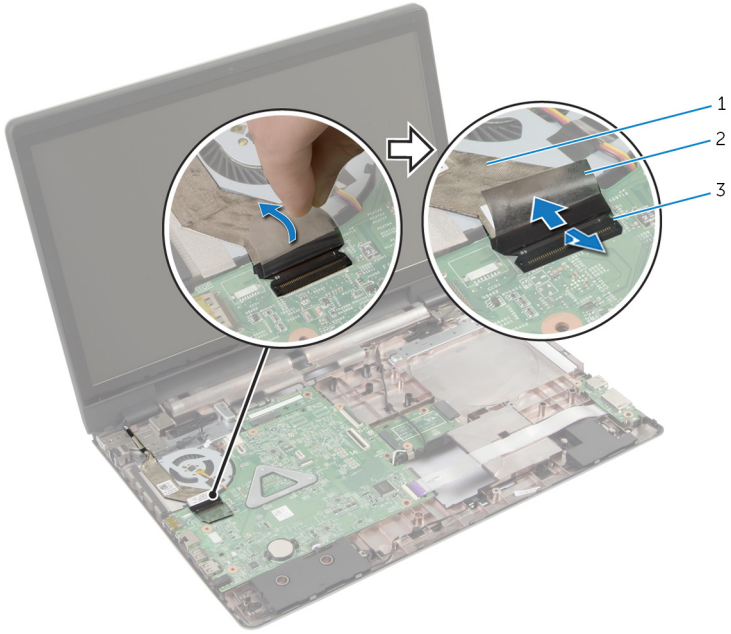

- 1 display cable
2 tape
3 connector latch

- 8** Peel off the display cable from the fan.
- 9** Remove the screws that secure the display assembly to the computer base.
- 10** Note the antenna cable routing and remove the cable from the routing guides on the computer base.

11 Lift the display assembly off the computer base.

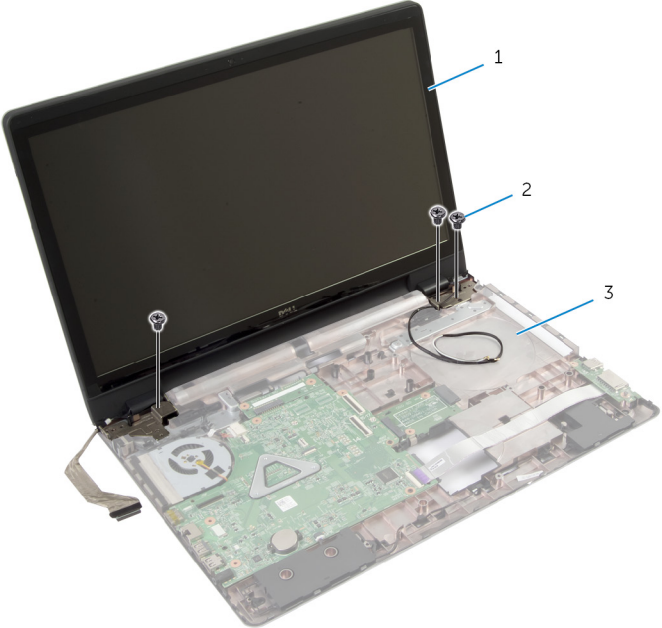

- 1 display assembly
- 3 computer base

- 2 screws (3)

Replacing the Display Assembly



WARNING: Before working inside your computer, read the safety information that shipped with your computer and follow the steps in [Before Working Inside Your Computer](#). After working inside your computer, follow the instructions in [After Working Inside Your Computer](#). For more safety best practices, see the Regulatory Compliance home page at dell.com/regulatory_compliance.

Procedure



NOTE: These instructions are applicable only for laptops with a non-touchscreen display.

- 1 Place the display assembly on the computer base and align the screw holes on the display assembly with the screw holes on the computer base.
- 2 Replace the screws that secure the display assembly to the computer base.
- 3 Route the antenna cables through the routing guides on the computer base.
- 4 Adhere the display cable to the fan.
- 5 Connect the display cable to the system board.
- 6 Adhere the tape that secures the display cable to the system board.
- 7 Close the display and turn the computer over.
- 8 Insert the antenna cables through the slot on the computer base.
- 9 Route the antenna cables on the computer base.
- 10 Connect the antenna cables to the wireless card.

Post-requisites

- 1 Replace the [palm rest](#).
- 2 Replace the [keyboard](#).
- 3 Follow the procedure from step 4 to step 5 in replacing the [optical drive](#).
- 4 Follow the procedure from step 3 to step 5 in replacing the [hard drive](#).
- 5 Replace the [base cover](#).

6 Replace the [battery](#).

Removing the Display Bezel



WARNING: Before working inside your computer, read the safety information that shipped with your computer and follow the steps in [Before Working Inside Your Computer](#). After working inside your computer, follow the instructions in [After Working Inside Your Computer](#). For more safety best practices, see the Regulatory Compliance home page at dell.com/regulatory_compliance.

Prerequisites

- 1 Remove the [base cover](#).
- 2 Remove the [battery](#).
- 3 Follow the procedures from step 1 to step 3 in removing the [hard drive](#).
- 4 Follow the procedures from step 1 to step 2 in removing the [optical drive](#).
- 5 Remove the [keyboard](#).
- 6 Remove the [palm rest](#).
- 7 Remove the [display assembly](#).

Procedure

Using your fingertips, carefully pry up the inside edges of the display bezel and lift the display bezel off the display assembly.

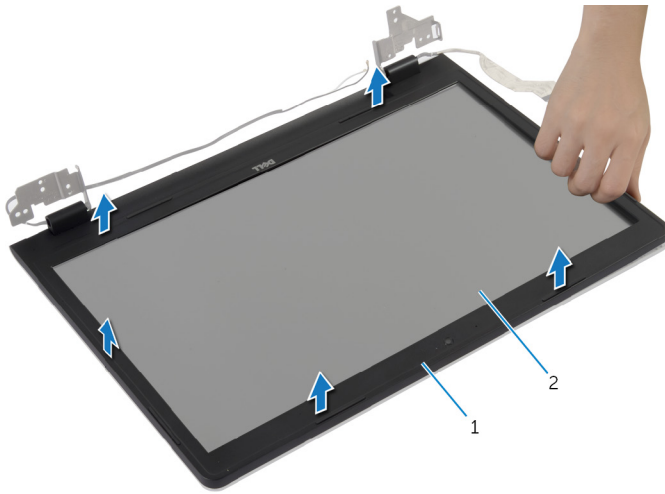

1 display bezel

2 display panel

Replacing the Display Bezel



WARNING: Before working inside your computer, read the safety information that shipped with your computer and follow the steps in [Before Working Inside Your Computer](#). After working inside your computer, follow the instructions in [After Working Inside Your Computer](#). For more safety best practices, see the Regulatory Compliance home page at dell.com/regulatory_compliance.

Procedure

Align the display bezel with the display back-cover and gently snap the display bezel into place.

Post-requisites

- 1 Replace the [display assembly](#).
- 2 Replace the [palm rest](#).
- 3 Replace the [keyboard](#).
- 4 Follow the procedure from step 4 to step 5 in replacing the [optical drive](#).
- 5 Follow the procedure from step 3 to step 5 in replacing the [hard drive](#).
- 6 Replace the [base cover](#).
- 7 Replace the [battery](#).

Removing the Camera



WARNING: Before working inside your computer, read the safety information that shipped with your computer and follow the steps in [Before Working Inside Your Computer](#). After working inside your computer, follow the instructions in [After Working Inside Your Computer](#). For more safety best practices, see the Regulatory Compliance home page at dell.com/regulatory_compliance.

Prerequisites

- 1 Remove the [battery](#).
- 2 Remove the [base cover](#).
- 3 Follow the procedure from step 1 to step 3 in removing the [hard drive](#).
- 4 Follow the procedure from step 1 to step 2 in removing the [optical drive](#).
- 5 Remove the [keyboard](#).
- 6 Remove the [palm rest](#).
- 7 Remove the [display assembly](#).
- 8 Remove the [display bezel](#).

Procedure

- 1 Carefully lift and peel off the camera from the display back-cover.
- 2 Disconnect the camera cable from the camera.

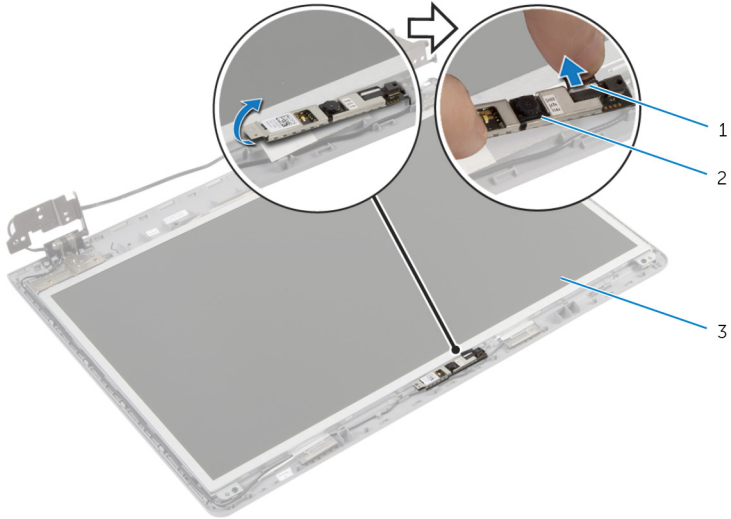

- 1 camera cable
- 3 display back-cover

- 2 camera

Replacing the Camera



WARNING: Before working inside your computer, read the safety information that shipped with your computer and follow the steps in [Before Working Inside Your Computer](#). After working inside your computer, follow the instructions in [After Working Inside Your Computer](#). For more safety best practices, see the Regulatory Compliance home page at dell.com/regulatory_compliance.

Procedure

- 1 Connect the camera cable to the camera.
- 2 Use the alignment post on the display back-cover to place the camera in position.
- 3 Adhere the camera to the display back-cover.

Post-requisites

- 1 Replace the [display bezel](#).
- 2 Replace the [display assembly](#).
- 3 Replace the [palm rest](#).
- 4 Replace the [keyboard](#).
- 5 Follow the procedure from step 4 to step 5 in replacing the [optical drive](#).
- 6 Follow the procedure from step 3 to step 5 in replacing the [hard drive](#).
- 7 Replace the [base cover](#).
- 8 Replace the [battery](#).

Removing the Display Panel



WARNING: Before working inside your computer, read the safety information that shipped with your computer and follow the steps in [Before Working Inside Your Computer](#). After working inside your computer, follow the instructions in [After Working Inside Your Computer](#). For more safety best practices, see the Regulatory Compliance home page at dell.com/regulatory_compliance.

Prerequisites

- 1 Remove the [battery](#).
- 2 Remove the [base cover](#).
- 3 Follow the instructions from step 1 to step 3 in removing the [hard drive](#).
- 4 Follow the instructions from step 1 to step 2 in removing the [optical drive](#).
- 5 Remove the [keyboard](#).
- 6 Remove the [palm rest](#).
- 7 Remove the [display assembly](#).
- 8 Remove the [display bezel](#).
- 9 Remove the [camera](#).

Procedure

- 1 Note the cable routing and remove the display cable from the routing guides on the display-back cover.
- 2 Remove the screws that secure the display panel to the display back-cover.

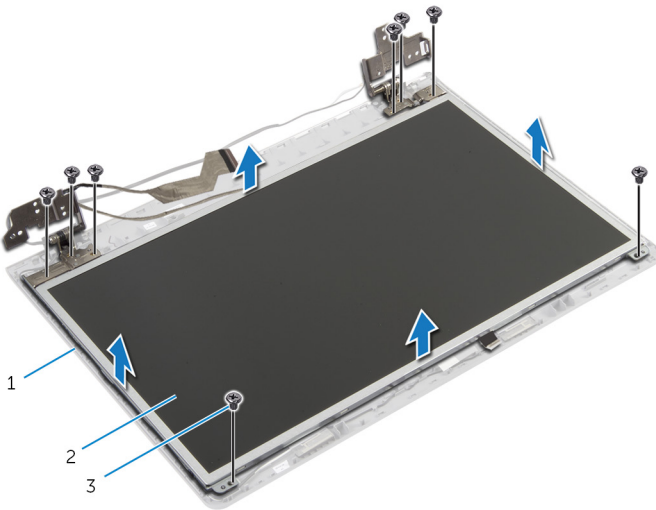

- | | | | |
|---|--------------------|---|---------------|
| 1 | display back-cover | 2 | display panel |
| 3 | screws (8) | | |

- 3 Gently lift the display panel and turn it over.
- 4 Peel off the tape that secures the display cable to the display panel.

- 5 Lift the connector latch and disconnect the display cable from the display panel.

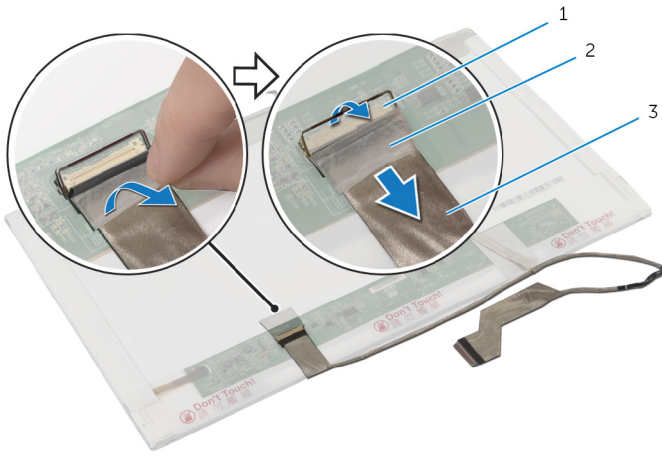

- 1 connector latch
- 3 display cable

- 2 tape

Replacing the Display Panel



WARNING: Before working inside your computer, read the safety information that shipped with your computer and follow the steps in [Before Working Inside Your Computer](#). After working inside your computer, follow the instructions in [After Working Inside Your Computer](#). For more safety best practices, see the Regulatory Compliance home page at dell.com/regulatory_compliance.

Procedure

- 1 Connect the display cable to the display panel and press down the connector latch to secure the cable.
- 2 Adhere the tape that secures the display cable to the display panel.
- 3 Gently place the display panel on the display back-cover.
- 4 Align the screw holes on the display panel with the screw holes on the display back-cover.
- 5 Replace the screws that secure the display panel to the display back-cover.
- 6 Route the display cable through the routing guides on the display back-cover.

Post-requisites

- 1 Replace the [camera](#).
- 2 Replace the [display bezel](#).
- 3 Replace the [display assembly](#).
- 4 Replace the [palm rest](#).
- 5 Replace the [keyboard](#).
- 6 Follow the procedure from step 4 to step 5 in replacing the [optical drive](#).
- 7 Follow the procedure from step 3 to step 5 in replacing the [hard drive](#).
- 8 Replace the [base cover](#).
- 9 Replace the [battery](#).

Removing the Display Back-Cover and Antenna Assembly

 **WARNING:** Before working inside your computer, read the safety information that shipped with your computer and follow the steps in [Before Working Inside Your Computer](#). After working inside your computer, follow the instructions in [After Working Inside Your Computer](#). For more safety best practices, see the Regulatory Compliance home page at dell.com/regulatory_compliance.

Prerequisites

 **NOTE:** These instruction are applicable only to laptops with a non-touchscreen display.

- 1 Remove the [battery](#).
- 2 Remove the [base cover](#).
- 3 Follow the procedure from step 1 to step 3 in removing the [hard drive](#).
- 4 Follow the procedure from step 1 to step 2 in removing the [optical drive](#).
- 5 Remove the [keyboard](#).
- 6 Remove the [palm rest](#).
- 7 Remove the [display assembly](#).
- 8 Remove the [display bezel](#).
- 9 Remove the [camera](#).
- 10 Follow the procedure from step 1 to 3 in removing the [display panel](#).

Procedure

- 1 On the display back-cover and antenna assembly, peel off the tape that secures the antenna cables to the display back-cover.
- 2 Remove the antenna cables from the routing guides on the display back-cover.

3 Lift the antenna cables away from the display back-cover.

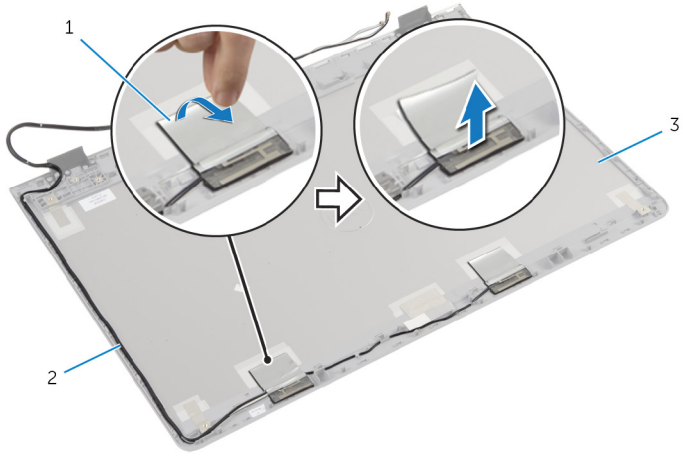

1 tape

2 antenna cables

3 display back-cover and
antenna assembly

Replacing the Display Back-Cover and Antenna Assembly

 **WARNING:** Before working inside your computer, read the safety information that shipped with your computer and follow the steps in [Before Working Inside Your Computer](#). After working inside your computer, follow the instructions in [After Working Inside Your Computer](#). For more safety best practices, see the Regulatory Compliance home page at dell.com/regulatory_compliance.

Procedure

- 1 Route the antenna cables through the routing guides on the display back cover.
- 2 Adhere the tape that secures the antenna cables to the display back-cover.

Post-requisite

- 1 Follow the procedure from step 3 to 6 in replacing the [display panel](#).
- 2 Replace the [camera](#).
- 3 Replace the [display bezel](#).
- 4 Replace the [display assembly](#).
- 5 Replace the [palm rest](#).
- 6 Replace the [keyboard](#).
- 7 Follow the procedure from step 1 to step 2 in replacing the [optical drive](#).
- 8 Follow the procedure from step 1 to step 3 in replacing the [hard drive](#).
- 9 Replace the [base cover](#).
- 10 Replace the [battery](#).

Flashing the BIOS



You may need to flash (update) the BIOS when an update is available or when you replace the system board. To flash the BIOS:

- 1 Turn on the computer.
- 2 Go to **dell.com/support**.
- 3 If you have your computer's Service Tag, type your computer's Service Tag and click **Submit**.
If you do not have your computer's Service Tag, click **Detect My Product** to allow automatic detection of the Service Tag.
 **NOTE:** If the Service Tag cannot be detected automatically, select your product under the product categories.
- 4 Click **Get Drivers and Downloads**.
- 5 Click **View All Drivers**.
- 6 In the **Operating System** drop-down, select the operating system installed on your computer.
- 7 Click **BIOS**.
- 8 Click **Download File** to download the latest version of the BIOS for your computer.
- 9 On the next page, select **Single-file download** and click **Continue**.
- 10 Save the file and once the download is complete, navigate to the folder where you saved the BIOS update file.
- 11 Double-click the BIOS update file icon and follow the instructions on the screen.

Getting Help and Contacting Dell

Self-Help Resources

You can get information and help on Dell products and services using these online self-help resources:

Self-Help Information	Self-Help Options
Accessing Windows Help	Windows 8 — Open the Search charm, type Help and Support in the search box and press <Enter>. Windows 7 — Click Start  → Help and Support .
Information about Dell products and services	See dell.com
Troubleshooting information, user manuals, setup instructions, product specifications, technical help blogs, drivers, software updates, and so on	See dell.com/support
Information about Microsoft Windows 8	See dell.com/windows8
Information about Microsoft Windows 7	Click Start  → All Programs → Dell Help Documentation
Learn about your operating system, setting up and using your computer, data backup, diagnostics, and so on.	See <i>Me and My Dell</i> at dell.com/support/manuals .

Contacting Dell

To contact Dell for sales, technical support, or customer service issues, see **dell.com/contactdell**.

 **NOTE:** Availability varies by country and product, and some services may not be available in your country.



NOTE: If you do not have an active internet connection, you can find contact information on your purchase invoice, packing slip, bill, or Dell product catalog.