

Desk Mount Articulating Tablet Arm with Locking Security Clamp

ARMTBLTI



*actual product may vary from photos

DE: Bedienungsanleitung - de.startech.com

FR: Guide de l'utilisateur - fr.startech.com

ES: Guía del usuario - es.startech.com

IT: Guida per l'uso - it.startech.com

NL: Gebruiksaanwijzing - nl.startech.com

PT: Guia do usuário - pt.startech.com

For the latest information, technical specifications, and support for this product, please visit www.startech.com/ARMTBLTI.







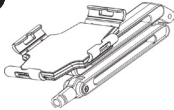

Use of Trademarks, Registered Trademarks, and other Protected Names and Symbols

This manual may make reference to trademarks, registered trademarks, and other protected names and/or symbols of third-party companies not related in any way to StarTech.com. Where they occur these references are for illustrative purposes only and do not represent an endorsement of a product or service by StarTech.com, or an endorsement of the product(s) to which this manual applies by the third-party company in question. Regardless of any direct acknowledgement elsewhere in the body of this document, StarTech.com hereby acknowledges that all trademarks, registered trademarks, service marks, and other protected names and/or symbols contained in this manual and related documents are the property of their respective holders.

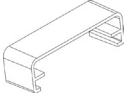
Table of Contents

Packaging Contents	1
Product Diagram	2
Installation	2
Desk mounting	2
Attach a tablet.....	3
Adjust the tension of the mounting arm.....	5
Charge or sync the tablet.....	5
Specifications	6
Technical Support	7
Warranty Information	7

Packaging Contents

<p>1</p>  <p>Articulating Tablet Arm Qty: 1</p>	<p>2</p>  <p>Desk Clamp Qty: 1</p>	<p>3</p>  <p>Cable Management Clips Qty: 2</p>
<p>4</p>  <p>EVA Cushion Qty: 1</p>	<p>5</p>  <p>2.5 mm Allen Wrench Qty: 1</p>	<p>6</p>  <p>3 mm Allen Wrench Qty: 1</p>
<p>7</p>  <p>Keys Qty: 2</p>	<p>8</p>  <p>Security Wrench Qty: 1</p>	<p>9</p>  <p>Instruction manual Qty: 1</p>

Product Diagram

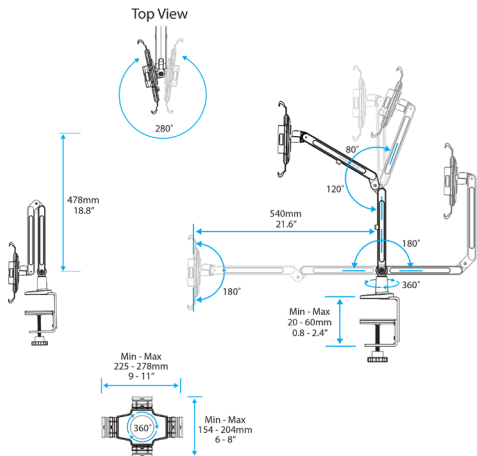

Installation

Warning: It's the installer's responsibility to make sure that the combined weight of all of the components doesn't exceed the maximum **1 kg (2.2 lb)** weight capacity of the mounting arm.

Desk mounting

1. On the base of the desk clamp (#2), turn the hand screw to the right until the clamp has just enough space to attach to the desk or table.
2. Slide the base mount onto the desk or table, and tighten the hand screw until it's secure.



Tighten the security ring on the base mount

When tightened, the security ring locks the hand screw in position to prevent people from removing the tablet arm from the desk.

1. When the base mount is secured to the table, place the rounded end of the security wrench (#8) onto the security ring on the base mount.
2. Turn the security wrench (#8) to the right to tighten the security ring.

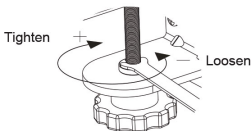

Attach a tablet

Warning: The claws on the articulating tablet arm hold the tablet in place. To avoid damaging the arm, don't attempt to adjust the claws when they're locked.

1. Place the key (#7) over the knob located on the back of the tablet mount, and turn the key to the right.

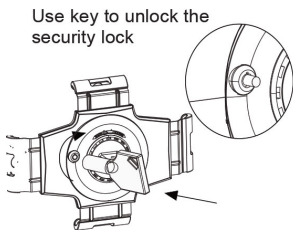

2. Move the yellow tab on the back of the tablet mount to the right to the unlocked position.

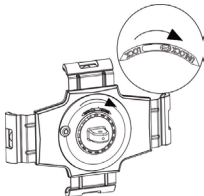

3. Extend each of the claws by pulling it outwards.

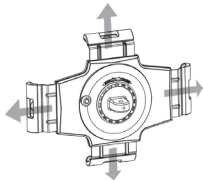

4. Carefully place a tablet inside of the extended claws.

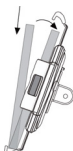

Note: If you're using a thin tablet with the mounting arm, attach the included EVA cushion (#4) to the indicated circular position on the tablet mount.

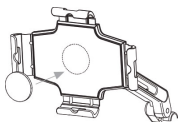

5. Move the yellow tab on the back of the tablet mount to the left to the locked position.
6. Push each of the claws towards the tablet until the tablet is secured within the mount.
7. Push in the knob at the back of the tablet mount to securely lock the tablet into the mount.

Adjust the tension of the mounting arm

1. Insert the 2.5 mm Allen wrench (**#5**) into the nut that corresponds to the hinge that you want to adjust.
2. To loosen the tension, turn the Allen wrench (**#5**) to the left. To increase the tension, turn the Allen wrench (**#5**) to the right.

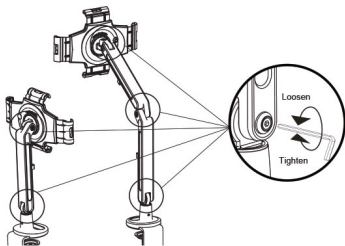

Charge or sync the tablet

You can charge or sync the tablet while it's in the mounting arm and use the cable management clips (**#3**) to manage the cable.

1. Using the holes in the mounting claws, attach a cable to the tablet.

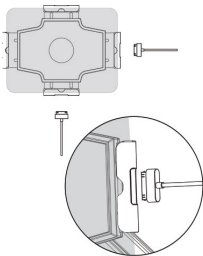

2. Run the cable down the length of the mounting arm and snap the clips (#3) over the cable and onto the mounting arm to keep the cable in place.

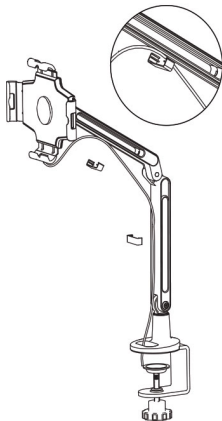

Specifications

Weight Capacity

1 kg (2.2 lb)

Tablet Size

9 to 11"

**Maximum Mounting Surface
Thickness**

0.79 to 2.36" (20 to 60 mm)

Technical Support

StarTech.com's lifetime technical support is an integral part of our commitment to provide industry-leading solutions. If you ever need help with your product, visit www.startech.com/support and access our comprehensive selection of online tools, documentation, and downloads.

For the latest drivers and software, please visit www.startech.com/downloads.

Warranty Information

This product is backed by a two-year warranty.

StarTech.com warrants its products against defects in materials and workmanship for the periods noted, following the initial date of purchase. During this period, the products may be returned for repair, or replacement with equivalent products at our discretion. The warranty covers parts and labor costs only. StarTech.com does not warrant its products from defects or damages arising from misuse, abuse, alteration, or normal wear and tear.

Limitation of Liability

In no event shall the liability of StarTech.com Ltd. and StarTech.com USA LLP (or their officers, directors, employees or agents) for any damages (whether direct or indirect, special, punitive, incidental, consequential, or otherwise), loss of profits, loss of business, or any pecuniary loss, arising out of or related to the use of the product exceed the actual price paid for the product. Some states do not allow the exclusion or limitation of incidental or consequential damages. If such laws apply, the limitations or exclusions contained in this statement may not apply to you.

Hard-to-find made easy. At StarTech.com, that isn't a slogan. It's a promise.

StarTech.com is your one-stop source for every connectivity part you need. From the latest technology to legacy products — and all the parts that bridge the old and new — we can help you find the parts that connect your solutions.

We make it easy to locate the parts, and we quickly deliver them wherever they need to go. Just talk to one of our tech advisors or visit our website. You'll be connected to the products you need in no time.

Visit www.startech.com for complete information on all StarTech.com products and to access exclusive resources and time-saving tools.

StarTech.com is an ISO 9001 Registered manufacturer of connectivity and technology parts. StarTech.com was founded in 1985 and has operations in the United States, Canada, the United Kingdom and Taiwan servicing a worldwide market.