

ViewSonic®



Pro10 Series Professional DLP® Projector User Guide

IMPORTANT: Please read this User Guide to obtain important information on installing and using your product in a safe manner, as well as registering your product for future service. Warranty information contained in this User Guide will describe your limited coverage from ViewSonic Corporation, which is also found on our web site at <http://www.viewsonic.com> in English, or in specific languages using the Regional selection box in the upper right corner of our website. "Antes de operar su equipo lea cuidadosamente las instrucciones en este manual"

Model No. VS15149/VS15541

Compliance Information

FCC Statement

This equipment has been tested and found to comply with the limits for a Class A digital device, pursuant to part 15 of the FCC Rules. These limits are designed to provide reasonable protection against harmful interference when the equipment is operated in a commercial environment. This equipment generates, uses, and can radiate radio frequency energy and, if not installed and used in accordance with the instruction manual, may cause harmful interference to radio communications.

Operation of this equipment in a residential area is likely to cause harmful interference in which case the user will be required to correct the interference at his own expense.

Warning: You are cautioned that changes or modifications not expressly approved by the party responsible for compliance could void your authority to operate the equipment.

For Canada

CAN ICES-3(A)/NMB-3(A)

CE Conformity for European Countries

 The device complies with the EMC Directive 2004/108/EC and Low Voltage Directive 2006/95/EC.

Warning -

- This product must not be used in residential areas.
- This product may cause interference if used in residential areas.

Such use must be avoided unless the user takes special measures to reduce electromagnetic emissions to prevent interference to the reception of radio and television broadcasts.

Following information is only for EU-member states:

The mark is in compliance with the Waste Electrical and Electronic Equipment Directive 2002/96/EC (WEEE).

The mark indicates the requirement NOT to dispose the equipment including any spent or discarded batteries or accumulators as unsorted municipal waste, but use the return and collection systems available.

If the batteries, accumulators and button cells included with this equipment, display the chemical symbol Hg, Cd, or Pb, then it means that the battery has a heavy metal content of more than 0.0005% Mercury or more than, 0.002% Cadmium, or more than 0.004% Lead.



Important Safety Instructions

1. Read these instructions.
2. Keep these instructions.
3. Heed all warnings.
4. Follow all instructions.
5. Do not use this unit near water.
6. Clean with a soft, dry cloth.
7. Do not block any ventilation openings. Install the unit in accordance with the manufacturer's instructions.
8. Do not install near any heat sources such as radiators, heat registers, stoves, or other devices (including amplifiers) that produce heat.
9. Do not defeat the safety purpose of the polarized or grounding-type plug. A polarized plug has two blades with one wider than the other. A grounding type plug has two blades and a third grounding prong. The wide blade and the third prong are provided for your safety. If the provided plug does not fit into your outlet, consult an electrician for replacement of the obsolete outlet.
10. Protect the power cord from being walked on or pinched particularly at plugs. Convenience receptacles and the point where they exit from the unit. Be sure that the power outlet is located near the unit so that it is easily accessible.
11. Only use attachments/accessories specified by the manufacturer.
12. Use only with the cart, stand, tripod, bracket, or table specified by the manufacturer, or sold with the unit. When a cart is used, use caution when moving the cart/unit combination to avoid injury from tipping over.
13. Unplug this unit when unused for long periods of time.
14. Refer all servicing to qualified service personnel. Servicing is required when the unit has been damaged in any way, such as: if the power-supply cord or plug is damaged, if liquid is spilled onto or objects fall into the unit, if the unit is exposed to rain or moisture, or if the unit does not operate normally or has been dropped.



Declaration of RoHS2 Compliance

This product has been designed and manufactured in compliance with Directive 2011/65/EU of the European Parliament and the Council on restriction of the use of certain hazardous substances in electrical and electronic equipment (RoHS2 Directive) and is deemed to comply with the maximum concentration values issued by the European Technical Adaptation Committee (TAC) as shown below:

Substance	Proposed Maximum Concentration	Actual Concentration
Lead (Pb)	0.1%	< 0.1%
Mercury (Hg)	0.1%	< 0.1%
Cadmium (Cd)	0.01%	< 0.01%
Hexavalent Chromium (Cr ⁶⁺)	0.1%	< 0.1%
Polybrominated biphenyls (PBB)	0.1%	< 0.1%
Polybrominated diphenyl ethers (PBDE)	0.1%	< 0.1%

Certain components of products as stated above are exempted under the Annex III of the RoHS2 Directives as noted below:

Examples of exempted components are:

- Mercury in cold cathode fluorescent lamps and external electrode fluorescent lamps (CCFL and EEFL) for special purposes not exceeding (per lamp):
 - Short length (≤ 500 mm): maximum 3.5 mg per lamp.
 - Medium length (> 500 mm and $\leq 1,500$ mm): maximum 5 mg per lamp.
 - Long length ($> 1,500$ mm): maximum 13 mg per lamp.
- Lead in glass of cathode ray tubes.
- Lead in glass of fluorescent tubes not exceeding 0.2% by weight.
- Lead as an alloying element in aluminium containing up to 0.4% lead by weight.
- Copper alloy containing up to 4% lead by weight.
- Lead in high melting temperature type solders (i.e. lead-based alloys containing 85% by weight or more lead).
- Electrical and electronic components containing lead in a glass or ceramic other than dielectric ceramic in capacitors, e.g. piezoelectronic devices, or in a glass or ceramic matrix compound.

Copyright Information

Copyright © ViewSonic® Corporation, 2013. All rights reserved.

Macintosh and Power Macintosh are registered trademarks of Apple Inc.

Microsoft, Windows, Windows NT, and the Windows logo are registered trademarks of Microsoft Corporation in the United States and other countries.

ViewSonic, the three birds logo, OnView, ViewMatch, and ViewMeter are registered trademarks of ViewSonic Corporation.

VESA is a registered trademark of the Video Electronics Standards Association. DPMS and DDC are trademarks of VESA.

PS/2, VGA and XGA are registered trademarks of International Business Machines Corporation.

Disclaimer: ViewSonic Corporation shall not be liable for technical or editorial errors or omissions contained herein; nor for incidental or consequential damages resulting from furnishing this material, or the performance or use of this product.

In the interest of continuing product improvement, ViewSonic Corporation reserves the right to change product specifications without notice. Information in this document may change without notice.

No part of this document may be copied, reproduced, or transmitted by any means, for any purpose without prior written permission from ViewSonic Corporation.

Product Registration

To fulfill possible future product needs, and to receive additional product information as it becomes available, please visit your region section on ViewSonic's website to register your product online.

The ViewSonic CD also provides an opportunity for you to print the product registration form. Upon completion, please mail or fax to a respective ViewSonic office. To find your registration form, use the directory ".\CD\Registration". Registering your product will best prepare you for future customer service needs.

Please print this user guide and fill the information in the "For Your Records" section.

For additional information, please see the "Customer Support" section in this guide.

For Your Records

Product Name:	Pro10 Series ViewSonic Professional DLP® Projector
Model Number:	VS15149/VS15541
Document Number:	Pro10 Series_UG_ENG Rev. 1A 05-06-13
Serial Number:	_____
Purchase Date:	_____

Product disposal at end of product life

The lamp in this product contains mercury which can be dangerous to you and the environment. Please use care and dispose of in accordance with local, state or federal laws.

ViewSonic respects the environment and is committed to working and living green. Thank you for being part of Smarter, Greener Computing. Please visit ViewSonic website to learn more.

USA & Canada: <http://www.viewsonic.com/company/green/recycle-program/>

Europe: <http://www.viewsoniceurope.com/uk/support/recycling-information/>

Taiwan: <http://recycle.epa.gov.tw/recycle/index2.aspx>

Notes on the AC Power Cord

AC Power Cord must meet the requirement of countries where you use this projector. Please confirm your AC plug type with the graphics below and ensure that the proper AC Power Cord is used. If the supplied AC Power Cord does not match your AC outlet, please contact your sales dealer. This projector is equipped with a grounding type AC line plug. Please ensure that your outlet fits the plug. Do not defeat the safety purpose of this grounding type plug. We highly recommend using a video source device also equipped with a grounding type AC line plug to prevent signal interference due to voltage fluctuations.

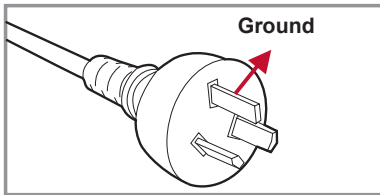

For Australia and Mainland China

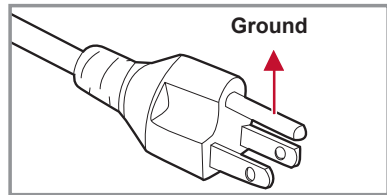

For the U.S.A and Canada

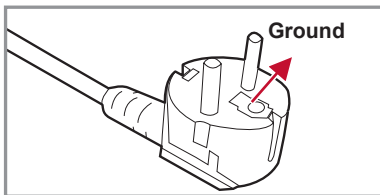

For Continental Europe

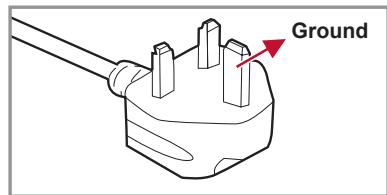

For the U.K.

Precautions



Please follow all warnings, precautions and maintenance as recommended in this user's guide.

- ■ Warning- Do not look into the projector's lens when the lamp is on. The bright light may hurt your eyes.
- ■ Warning- To reduce the risk of fire or electric shock, do not expose this projector to rain or moisture.
- ■ Warning- Please do not open or disassemble the projector as this may cause electric shock.
- ■ Warning- When replacing the lamp, please allow the unit to cool down. Follow instructions as described on pages 65-66.
- ■ Warning- This projector will detect the life of the lamp itself. Please be sure to change the lamp when it shows warning messages.
- ■ Warning- Reset the "Lamp Reset" function from the on-screen display "OPTIONS | Lamp Settings" menu after replacing the lamp module (refer to page 56).
- ■ Warning- When switching the projector off, please ensure the cooling cycle has been completed before disconnecting power. Allow 60 seconds for the projector to cool down.
- ■ Warning- Do not use lens cap when projector is in operation.
- ■ Warning- When the lamp is approaching the end of its lifetime, the message "Lamp Warning: Lamp life exceeded." will show on the screen. Please contact your local reseller or service center to change the lamp as soon as possible.
- ■ Warning- Do not look into or point the laser pointer on your remote control into your or someone's eyes. Laser pointer can cause permanent damage to eyesight.
- ■ Warning- Do not transport the projector with any lens installed.

Do:

- Turn off and unplug the power plug from the AC outlet before cleaning the product.
- Use a soft dry cloth with mild detergent to clean the display housing.
- Disconnect the power plug from AC outlet if the product is not being used for a long period of time.

Do not:

- Block the slots and openings on the unit provided for ventilation.
- Use abrasive cleaners, waxes or solvents to clean the unit.
- Use under the following conditions:
 - In extremely hot, cold or humid environments.
 - ▶ Ensure that the ambient room temperature is within 5°C ~ 40°C
 - ▶ Relative humidity is 10% ~ 85%
 - In areas susceptible to excessive dust and dirt.
 - Near any appliance generating a strong magnetic field.
 - In direct sunlight.

Table of Contents

Precautions	vi
-------------------	----

Introduction 9

Product Features	9
Package Overview	10
Product Overview	11
Main Unit	11
Control Panel	12
Connection Ports	13
Remote Control	14

Installation 16

Installing the Projector Lens	16
Connecting to Computer/Notebook	17
Connecting to Video Sources	18
Powering On/Off the Projector	19
Powering On the Projector	19
Powering Off the Projector	20
Warning Indicator	21
LED Lighting Message	21
Adjusting the Projected Image	22
Adjusting the Projector's Height	22
Adjusting the Projecting Image's Position	23

User Controls 26

Using the Control Panel	26
On-screen Display Menus	27
How to operate	27
Structure	28
PICTURE	32
PICTURE Advanced	34
SCREEN	36
SCREEN Geometry	37

SCREEN PIP / POP	40
SETTING	41
SETTING Lens Function	42
SETTING Security	43
SETTING Signal (RGB)	44
SETTING Signal (Video)	45
SETTING Audio Settings	46
SETTING Advanced	47
SETTING Network	48
SETTING Image Blending	52
OPTIONS	53
OPTIONS Lamp Settings	55
OPTIONS Remote Settings	56
OPTIONS Advanced	57

Appendices 58

Troubleshooting	58
Image Problems	58
Projector Problems	61
On Screen Messages	64
Replacing the Lamp	65
Replacing the Filter	67
Compatibility Modes	68
Remote Key Code	70
RS232 Pin Assignments	71
RS232 Protocol Function List	72
Ceiling Mount Installation	79
Specifications	80
Customer Support	82
Limited Warranty	83
Mexico Limited Warranty	85

Introduction

Product Features

- ▶ XGA (1024x768) / WXGA(1280x800), support resolution: Up to WUXGA @60Hz (Reduced Blanking) and UXGA @60Hz
- ▶ Single lamp system
- ▶ Power Zoom/Focus
- ▶ Power lens shift
- ▶ Dynamic Aperture
- ▶ 10W x 1 speaker
- ▶ Filter module
- ▶ Support PIP/POP function
- ▶ Support network management for remote control and monitoring

Package Overview

Unpack and inspect the box contents to ensure all parts listed below are in the box. If something is missing, please contact our customer service.

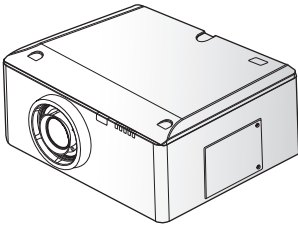

Projector with lens cover

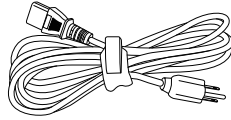

Power Cord

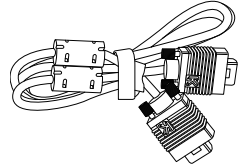

VGA Cable



Remote Control

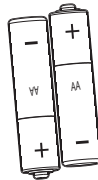

AA Batteries x 2
(For remote control)

Plug for wired remote at
projector side



Φ 3.5mm phone jack

Plug for wired remote at
remote control side



Φ 2.5mm phone jack

Documentation:

- User's Manual (CD)
- Quick Start Card
- Warranty Card (China only)



- Due to different applications in each Country, some regions may have different accessories.

Product Overview

Main Unit

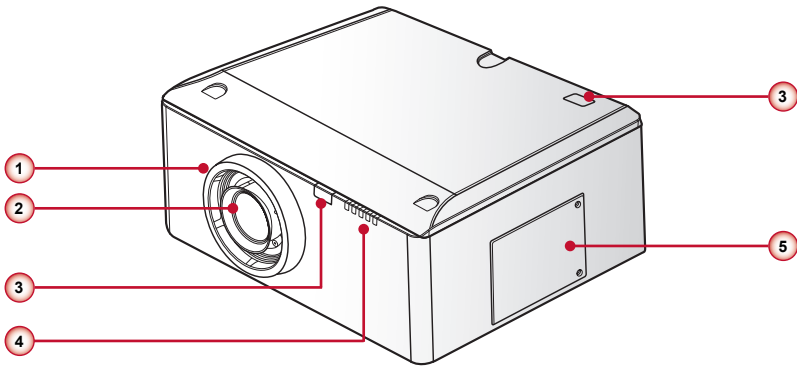

(Front View)

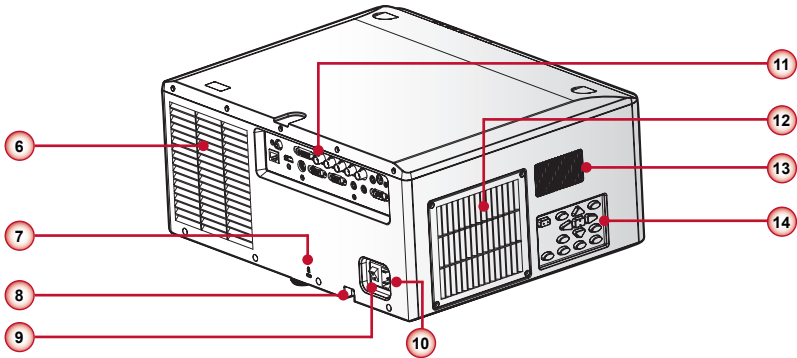

(Rear View)

- | | | |
|-------------------|---------------------|-------------------------|
| 1. Lens Ring | 6. Outlet Vent | 11. Connector Panel |
| 2. Zoom Lens | 7. Kensington Lock | 12. Inlet Vent & Filter |
| 3. IR Receivers | 8. Security Bar | 13. Audio Vent |
| 4. LED Indicators | 9. Power Switch | 14. Keypad Panel |
| 5. Lamp Door | 10. Power Connector | |



- Do not block projector in/out air vents and keep 30cm clearance around vents for air flow concern.

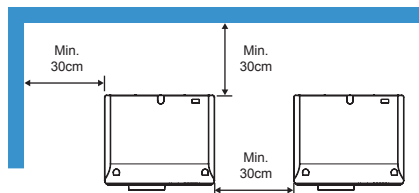

Control Panel

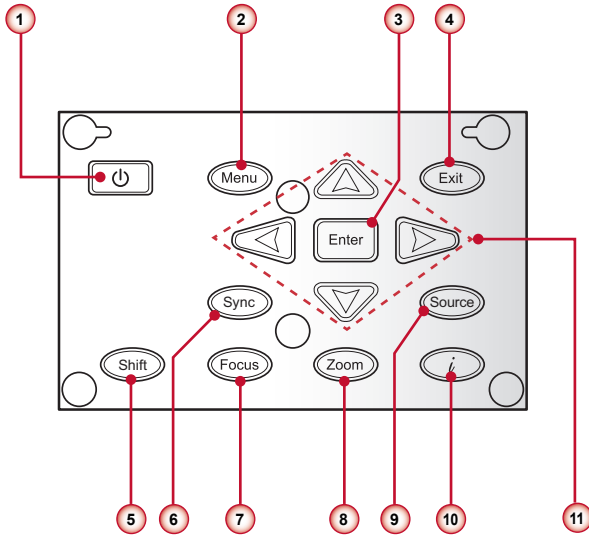

1.  / Power key & Power LED
2. Menu key
3. Enter key
4. Exit key
5. Shift key
6. Sync key
7. Focus key
8. Zoom key
9. Source key
10. Information key
11. Four directional select keys

Connection Ports

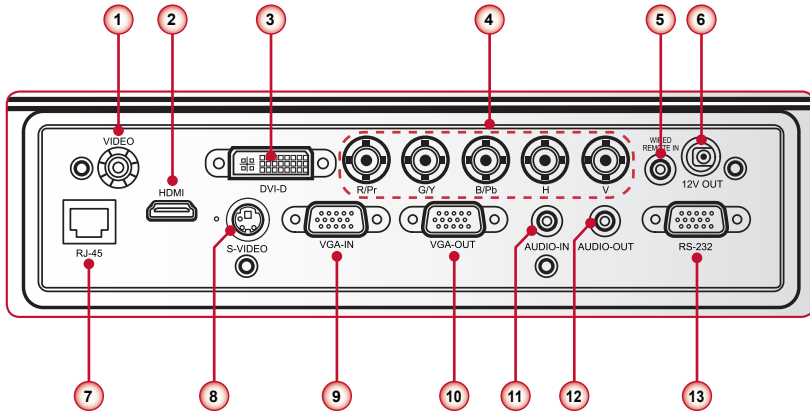

1. Composite Video Input Connector
2. HDMI Connector
3. DVI-D Connector
4. BNC Connector
5. Wired Remote Input Connector
6. 12V Trigger Relay Connector
7. RJ45 Network Connector
8. S-Video Input Connector
9. VGA Input Connector
10. VGA Output Connector
11. Audio Input Connector
12. Audio Output Connector
13. RS232 Connector (9-pin DIN Type)

Remote Control

1. Power ON
Power on the projector.
2. Pattern
Display a test pattern.
3. VGA
Switch to VGA source.
4. BNC
Switch to Component video source.
5. Sync
Synchronize projector with source.
6. Blank
Switch to a blank screen.
7. Four Directional Select Keys
Press up, down, left, right direction buttons to select items or make adjustments.
8. Exit
Exit a menu.
9. Menu
Launch the OSD main menu.
10. Focus
Adjust the lens focus.
11. Lamp PW
Adjust lamp power.
12. PIP
Launch the Picture-in-Picture function.
13. MyButton
Launch a user-defined setting.
14. RC ID
Set the remote control ID.
15. Reset
Reset the projector to factory default settings.
16. Standby
Turn off the projector.
17. Video
Switch to Composite Video source.

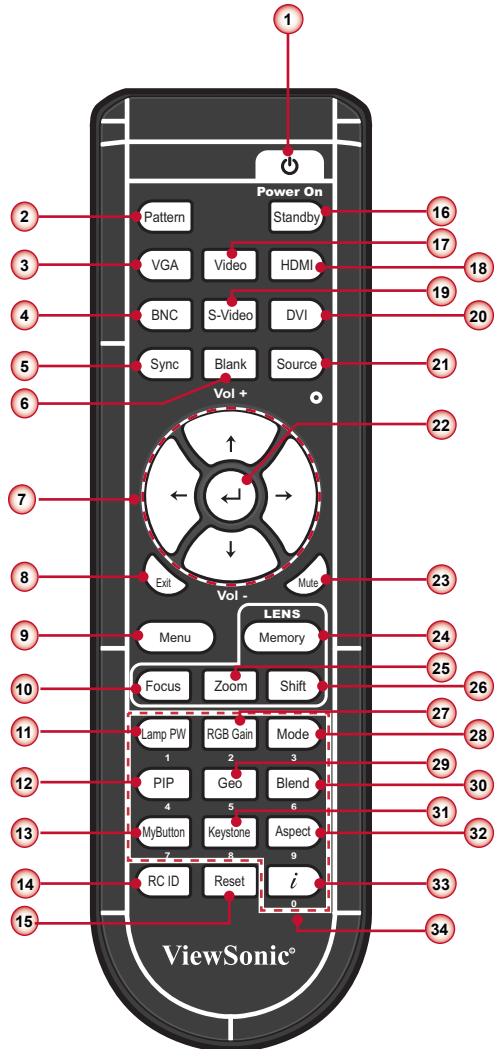

18. HDMI
Switch to HDMI source.
19. S-Video
Switch to S-Video source.
20. DVI
Switch to DVI source.
21. Source
Automatically scans for connected source.
22. Enter
Confirm your item selection.
23. Mute
Turn the projector audio off/on.
24. Memory
Save the current lens settings to the memory.
25. Zoom
Adjust the lens zoom function.
26. Shift
Adjust the lens shift up/down/left/right.
27. RGB Gain
Enter the color management setting page.
28. Mode
Select the display mode (Presentation, Bright, Movie, sRGB, DICOM SIM, and User).
29. Geo
Enable Geo tag information.
30. Blend
Adjust display blend function.
31. Keystone
Adjust image distortion caused by tilting the projector.
32. Aspect
Adjust the aspect ratio of the projected screen.
33. Information (i)
Display the projector information.
34. Numeric Keypad
Press “0~9” to input a numeric value such as a password in the “Security” settings.



- *When using the number keypad for password input, do not use “0” as part of the password.*

Installation

Installing the Projector Lens



Warning: Do not transport the projector with any lens installed.

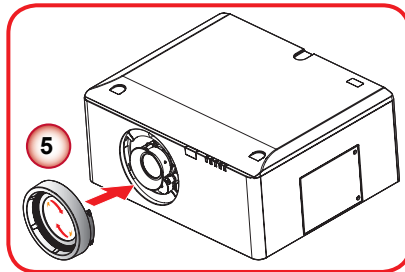
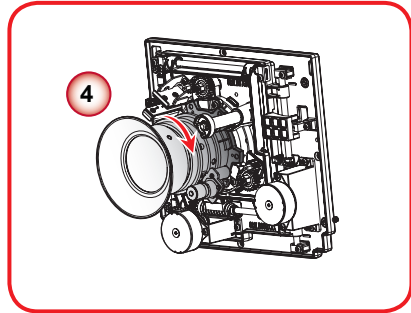
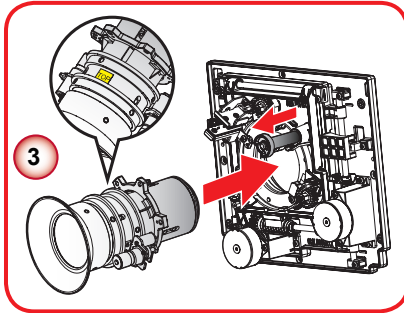
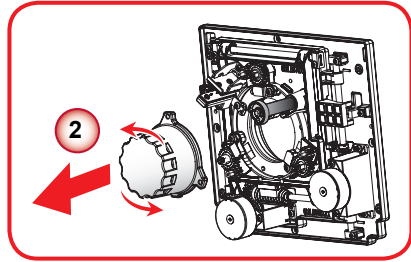
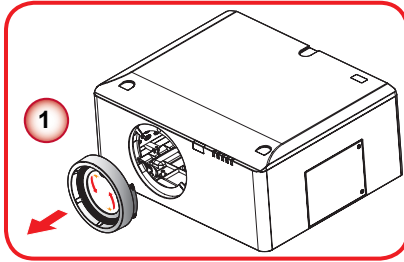

Lens Installing Procedure:

1. Remove the lens ring cover by counter-clockwise rotation. **1**
2. Remove the lens cap by counter-clockwise rotation. **2**
3. Pull the release bar and push the lens into position. **3**
4. Lens assembled by clockwise rotation. **4**
5. Lens ring cover assembled by clockwise rotation. **5**

NOTE

- Before installing or replacing the lens, switch off the power of the projector.
- Avoid using the remote control or projector keypad button to adjust the lens shift or zoom/focus while the lens is being attached.

Connecting to Computer/Notebook

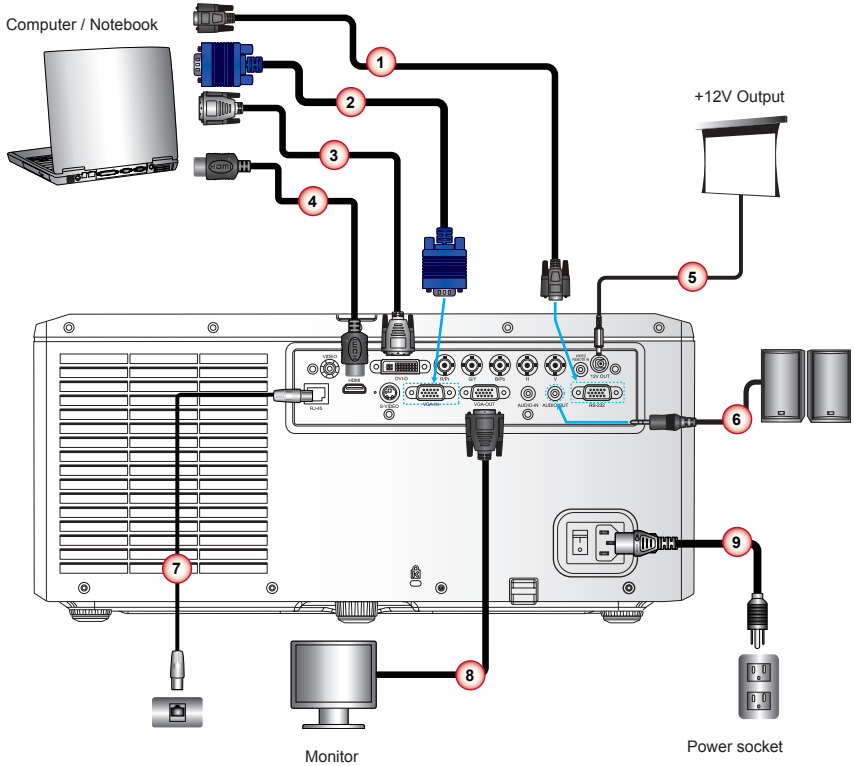

❖ Plug for 12V DC jack



Plug: ID Φ 1.7mm
OD Φ 4.0mm

❖ Plug for wired remote at projector side



Φ 3.5mm
phone jack

Power
Signal
Ground

❖ Plug for wired remote at remote control side



Φ 2.5mm
phone jack

Power
Signal
Ground

- | | |
|----------------|----------------|
| 1. RS232 Cable | 6. Audio Cable |
| 2. VGA Cable | 7. RJ45 Cable |
| 3. DVI-D Cable | 8. VGA Cable |
| 4. HDMI Cable | 9. Power Cord |
| 5. 12V DC Jack | |



■ Due to the difference in applications for each country, some regions may have different accessories.

Connecting to Video Sources

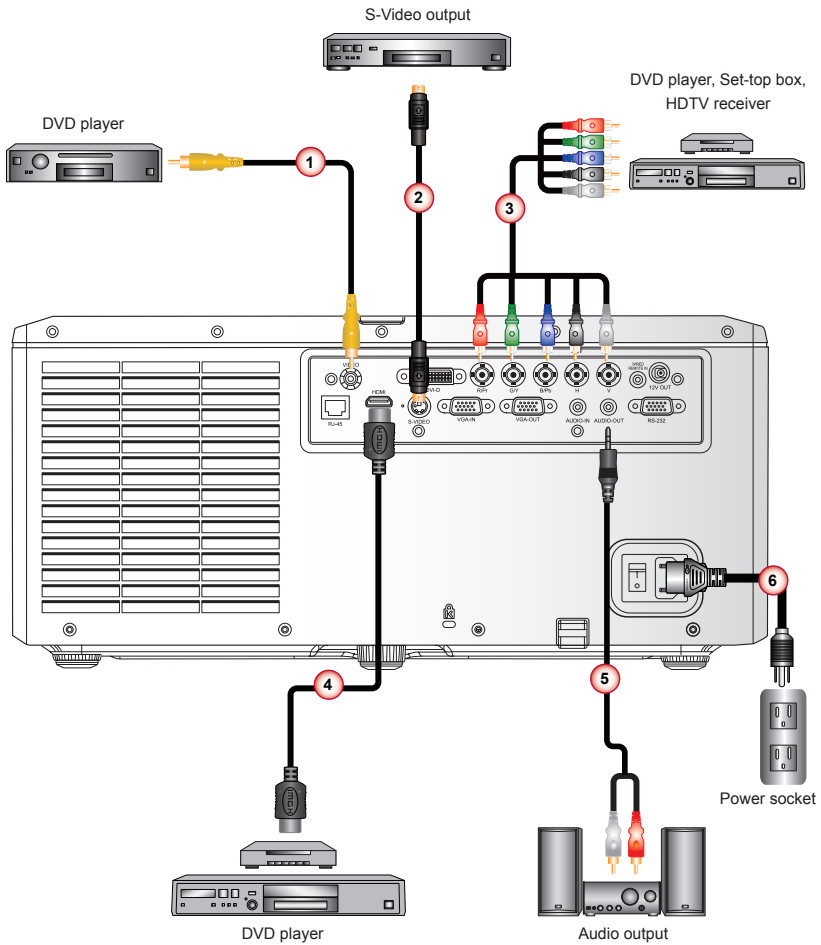

1. Composite Video cable
2. S-Video Cable
3. BNC Cable
4. HDMI Cable
5. Audio Cable
6. Power Cord



■ Due to the difference in applications for each country, some regions may have different accessories.

Powering On/Off the Projector

Powering On the Projector

1. Securely connect the power cord and signal cable. Power on the switch **1** and the Power LED flashes Blue.
2. Turn on the lamp by pressing the “” button either on the control panel of the projector or on the remote control **2**. The Power LED will turn blue.

The startup screen will display in approximately 10 seconds. The first time you use the projector, you will be asked to select the preferred language and power saving mode.

3. Turn on and connect the source that you want to display on the screen (computer, notebook, video player, etc). The projector will detect the source automatically. If not, push the menu button and go to “OPTIONS”. Make sure that “Auto Source” has been set to “Off”.

- ▶ If you connect multiple sources at the same time, press the direct source buttons on the control panel or on the remote control to switch between inputs.

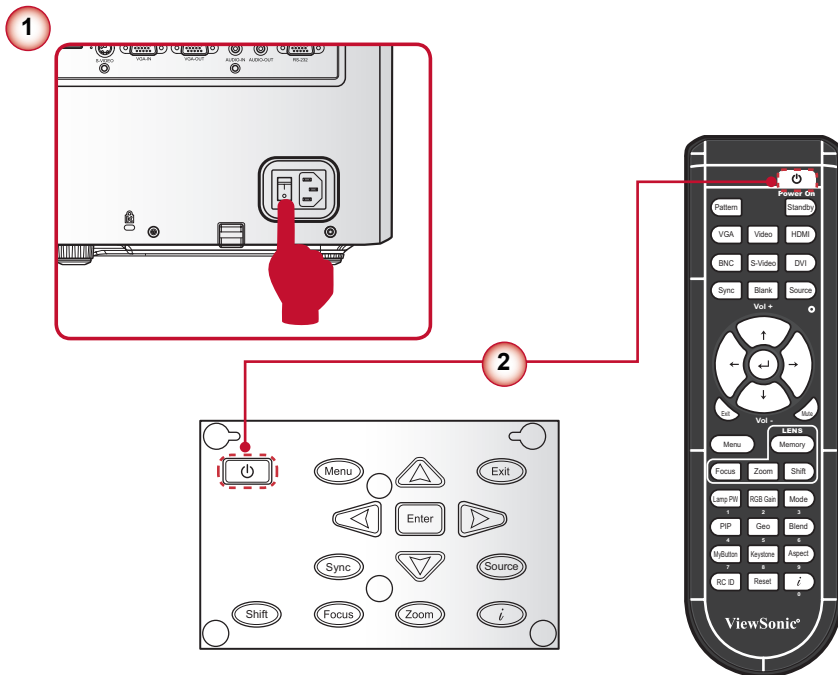

NOTE

- Turn on the projector first and then select the signal sources.

Powering Off the Projector

1. Press the “Standby” button on the remote control or the “⏻” button on the control panel to turn off the projector **1**. The following message will be displayed on the screen.

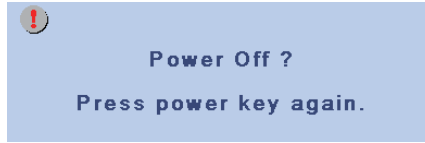

Press the “Standby” button on the remote control or the “⏻” button on the control panel again **1** to confirm otherwise the message will disappear after 15 seconds. When you press for the second time, the projector will shut down.

2. The cooling fans will complete the cooling cycle for about 60 seconds and the POWER LED will flash Blue. The projector has entered standby mode. If you wish to turn the projector back on, you must wait until the projector has completed the cooling cycle and has entered standby mode. Once in standby mode, simply press the “⏻” button either on the control panel of the projector or on the remote control to restart the projector. **2**
3. Power off the switch **3**.
4. Disconnect the power cord from the electrical outlet and from the projector.



- Do not turn on the projector immediately following the power of procedure.

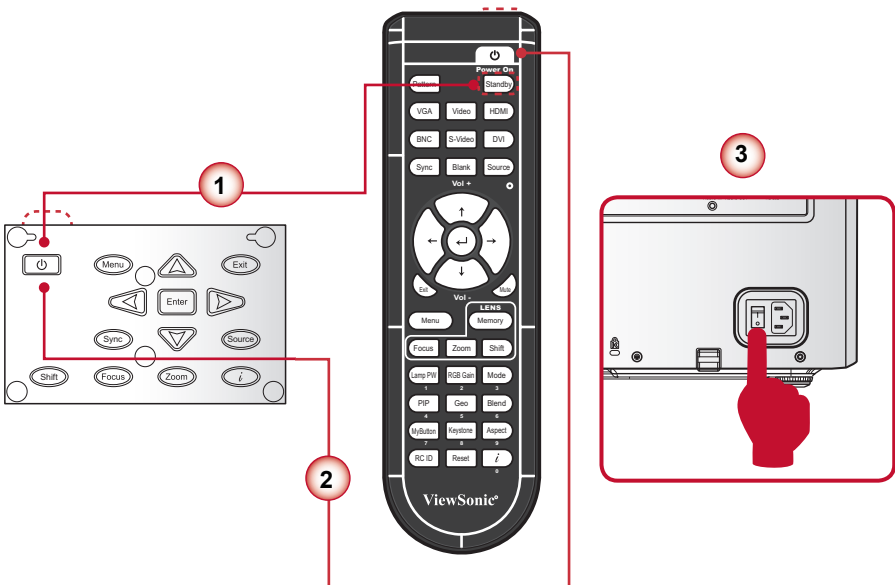

Warning Indicator

When the warning indicators (see below) come on, the projector will automatically shutdown:

- “LAMP” LED indicator is lit red and the “ERROR” LED indicator flashes red. This indicates that the lamp has failed.
- “TEMP” LED indicator is lit red and the “ERROR” LED indicator flashes red. This indicates the projector has overheated. Under normal conditions, the projector can be switched back on.
- “TEMP” LED indicator flashes red and the “ERROR” LED indicator flashes red. This indicates that the fan has failed.
- “ERROR” LED indicator flashes red and the “FILTER” LED indicator flashes red. This indicates that the filter needs replacement.
- “FILTER” LED indicator flashes red. This indicates that the filter needs to be cleaned.

Unplug the power cord from the projector, wait for 30 seconds and try again. If the warning indicator light up again, please contact your nearest service center for assistance.

LED Lighting Message

Message	Power LED		Lamp LED	Temp LED	Error LED	Filter LED
	Red	Blue	Red	Red	Red	Red
Standby State (LAN off)		Flashing				
Standby State (LAN On)		Flashing				
Power on & Lamp lighting		Steady light				
Power off (Cooling)		Flashing				
Error (Lamp fail)			Steady light		Flashing	
Error (Over Temp)				Steady light	Flashing	
Error (Fan fail)				Flashing	Flashing	
Error (Filter Switch)					Flashing	Flashing
Error (Filter Cleaning)						Flashing

Adjusting the Projected Image

Adjusting the Projector's Height

The projector is equipped with elevator rubber feet for adjusting the image height.

1. Locate the adjustable foot you wish to modify on the underside of the projector.
2. Rotate the adjustable ring clockwise to raise the projector or counter clockwise to lower it. Repeat with the remaining feet as needed.

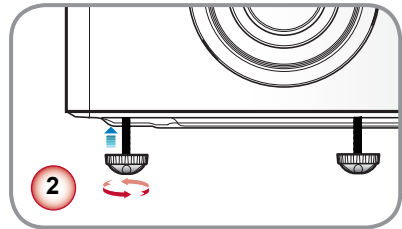
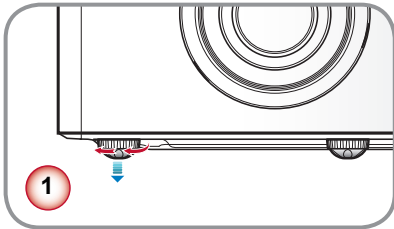

Adjusting the Projecting Image's Position

To determine where to position the projector, consider the size and shape of your screen, the location of your power outlets, and the distance between the projector and the rest of your equipment.

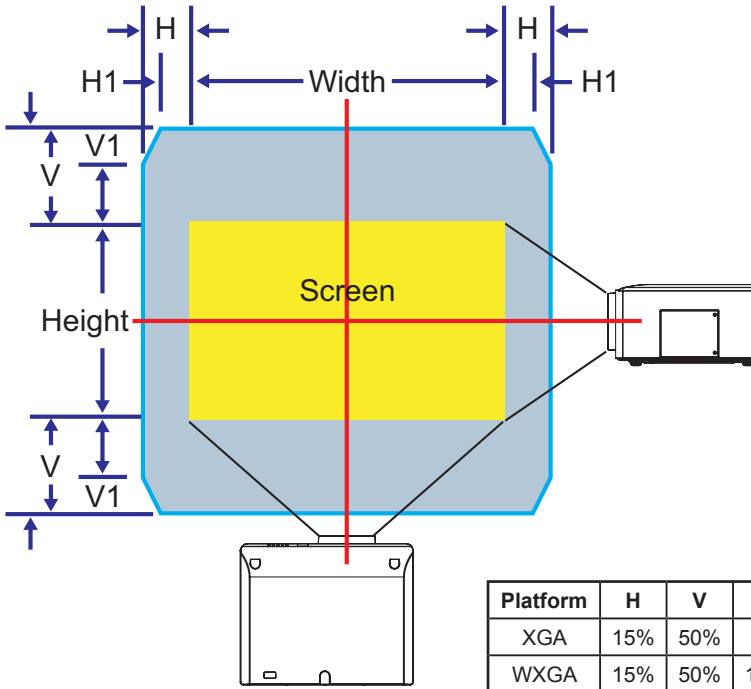

For XGA

Platform			XGA (4:3)					
DMD			0.7"					
Projection Lens			LEN-008	LEN-009	LEN-010			
			Wide Zoom	Standard	Long Zoom			
Throw Ratio			0.99-1.26	1.26-1.58	1.58-3.00			
Zoom Ratio			1.28X	1.25X	1.9X			
Throw Distance			1.01~7.68m	1.28~9.63m	1.61~18.29m			
Projection screen size			Projection distance (m)					
Throw Ratio			0.99	1.26	1.26	1.58	1.58	3.00
Diagonal (inch)	Height (m)	Width (m)	Min (m)	Max (m)	Min (m)	Max (m)	Min (m)	Max (m)
50	0.76	1.02	1.01	1.28	1.28	1.61	1.61	3.05
60	0.91	1.22	1.21	1.54	1.54	1.93	1.93	3.66
70	1.07	1.42	1.41	1.79	1.79	2.25	2.25	4.27

80	1.22	1.63	1.61	2.05	2.05	2.57	2.57	4.88
90	1.37	1.83	1.81	2.30	2.30	2.89	2.89	5.49
100	1.52	2.03	2.01	2.56	2.56	3.21	3.21	6.10
110	1.68	2.24	2.21	2.82	2.82	3.53	3.53	6.71
120	1.83	2.44	2.41	3.07	3.07	3.85	3.85	7.32
130	1.98	2.64	2.62	3.33	3.33	4.17	4.17	7.92
140	2.13	2.84	2.82	3.58	3.58	4.49	4.49	8.53
150	2.29	3.05	3.02	3.84	3.84	4.82	4.82	9.14
160	2.44	3.25	3.22	4.10	4.10	5.14	5.14	9.75
170	2.59	3.45	3.42	4.35	4.35	5.46	5.46	10.36
180	2.74	3.66	3.62	4.61	4.61	5.78	5.78	10.97
190	2.90	3.86	3.82	4.86	4.86	6.10	6.10	11.58
200	3.05	4.06	4.02	5.12	5.12	6.42	6.42	12.19
250	3.81	5.08	5.03	6.40	6.40	8.03	8.03	15.24
300	4.57	6.10	6.04	7.68	7.68	9.63	9.63	18.29

For WXGA

Platform			WXGA (16:10)					
DMD			0.65"					
Projection Lens			LEN-008		LEN-009		LEN-010	
			Wide Zoom		Standard		Long Zoom	
Throw Ratio			1.00-1.28		1.28-1.61		1.60-3.07	
Zoom Ratio			1.28X		1.25X		1.9X	
Throw Distance			1.08~8.27m		1.38~10.40m		1.72~19.84m	
Projection screen size			Projection distance (m)					
Throw Ratio			1.00	1.28	1.28	1.61	1.60	3.07
Diagonal (inch)	Height (m)	Width (m)	Min (m)	Max (m)	Min (m)	Max (m)	Min (m)	Max (m)
50	0.67	1.08	1.08	1.38	1.38	1.73	1.72	3.31
60	0.81	1.29	1.29	1.65	1.65	2.08	2.07	3.97
70	0.94	1.51	1.51	1.93	1.93	2.43	2.41	4.63
80	1.08	1.72	1.72	2.21	2.21	2.77	2.76	5.29
90	1.21	1.94	1.94	2.48	2.48	3.12	3.10	5.95
100	1.35	2.15	2.15	2.76	2.76	3.47	3.45	6.61
110	1.48	2.37	2.37	3.03	3.03	3.81	3.79	7.27
120	1.62	2.58	2.58	3.31	3.31	4.16	4.14	7.94
130	1.75	2.80	2.80	3.58	3.58	4.51	4.48	8.60
140	1.88	3.02	3.02	3.86	3.86	4.85	4.82	9.26
150	2.02	3.23	3.23	4.14	4.14	5.20	5.17	9.92
160	2.15	3.45	3.45	4.41	4.41	5.55	5.51	10.58

170	2.29	3.66	3.66	4.69	4.69	5.90	5.86	11.24
180	2.42	3.88	3.88	4.96	4.96	6.24	6.20	11.90
190	2.56	4.09	4.09	5.24	5.24	6.59	6.55	12.56
200	2.69	4.31	4.31	5.51	5.51	6.94	6.89	13.23
250	3.37	5.38	5.38	6.89	6.89	8.67	8.62	16.53
300	4.04	6.46	6.46	8.27	8.27	10.40	10.34	19.84

User Controls

Using the Control Panel

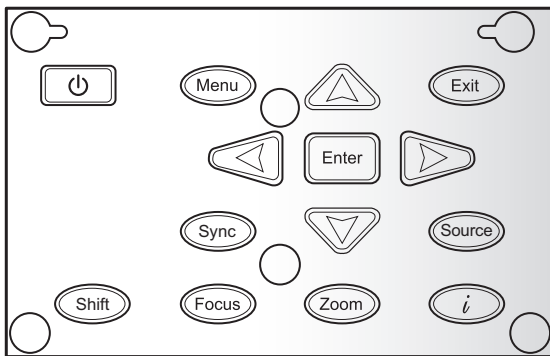

Name	Description
Power 	Turn the projector on/off.
Menu	Launch the on-screen display (OSD).
Exit	Exit a menu.
Enter	Confirm a selected item.
Four Directional Select Keys	1. Use ▲▼◀▶ to select items or make adjustments to your selection. 2. ▲/▼ act as short hot keys for Keystone +/- adjustment.
Sync	Synchronize the projector with the input source.
Source	Select an input signal.
Shift	Adjust the lens shift up/down/left/right.
Focus	Adjust the lens focus function.
Zoom	Adjust the lens zoom function.
Information	Display the projector's information.

On-screen Display Menus

The Projector has multilingual On-screen Display menus that allow you to make image adjustments and change a variety of settings. The projector will automatically detect the source.

How to operate

1. To open the OSD menu, press “Menu” on the Remote Control or Control Panel.
2. When OSD is displayed, use ▲ ▼ keys to select any item in the main menu. While making a selection on a particular page, press “Enter” key to enter sub menu.
3. Use ▲ ▼ keys to select the desired item in the sub menu and then press “Enter” key to view further settings. Adjust the settings by ◀ ▶ key.
4. Select the next item to be adjusted in the sub menu and adjust as described above.
5. Press “Enter” to confirm, and the screen will return to the main menu.
6. To exit, press “Menu” again. The OSD menu will close and the projector will automatically save the new settings.

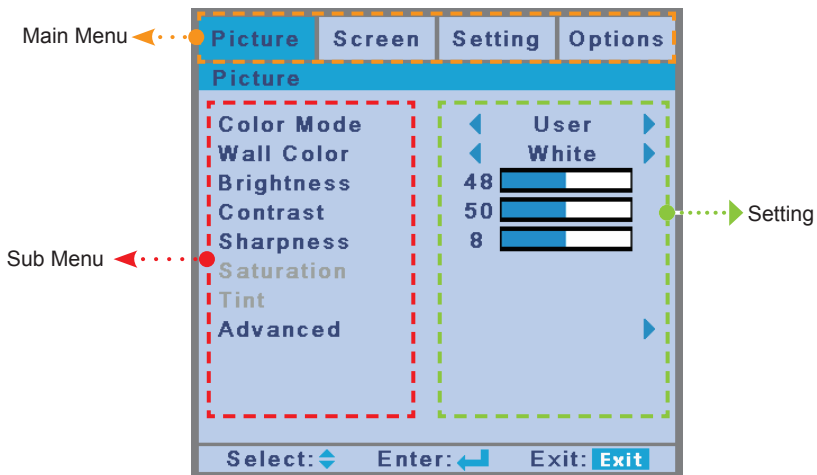

Structure



- Please note that the on-screen display (OSD) menus vary according to the signal type selected and the projector model you are using.

Main Menu	Sub Menu	Settings		
PICTURE	Color Mode	Presentation / Bright / Movie / sRGB / DICOM SIM. / User		
	Wall Color	White / Light Yellow / Light Blue / Pink / Dark Green		
	Brightness			
	Contrast			
	Sharpness			
	Saturation			
	Tint			
		Noise Reduction		
		BrilliantColor™	On / Off	
		Gamma	Film / Video / Graphics / Standard	
		DynamicBlack	On / Off	
		Color Temp.	Warm / Medium / Cool	
	Advanced	Color Space	Auto / RGB / YUV	
		Color Settings	Red Gain / Green Gain / Blue Gain / Red Bias / Green Bias / Blue Bias / Reset / Exit	
	Input Source	HDMI / DVI / VGA / BNC / S-Video / Video / Exit		
	Exit			
SCREEN	Aspect (for XGA)	4:3 / 16:9 / Native / Auto		
	Aspect (for WXGA)	4:3 / 16:10 / Native / Auto		
	Zoom			
	Overscan			
	H Image Shift			
	V Image Shift			
	Geometry	PC Mode	Off / On	
		Warp	Off / On	
		Keystone	Horizontal / Vertical / Pin Cushion/Barrel / Reset / Exit	
		4- Corner	Corner / X Offset / Y Offset / Reset / Exit	
		Curve	Point 1 / Point 2 / Point 3 / Point 4 / Point 5 / Point 6 / Point 7 / Point 8 / Point 9 / Reset / Exit	
		Rotation	Rotation / Pin Cushion/Barrel / Reset / Exit	
		V Keystone		

Main Menu	Sub Menu	Settings		
SCREEN	PIP / POP	Screen		
		PIP Location		
		PIP Size	1/16 / 1/25 / 1/36	
		PIP/POP Source	HDMI / VGA or DVI / S-Video / Video / BNC	
		Swap		
		Exit		
SETTING	Language		English / German / French / Spanish / Italian / Russian / Portuguese / Swedish / Simplified Chinese / Korean / Traditional Chinese / Turkish / Polish / Japanese / Norwegian / Exit	
	Projection		Front-Desktop / Rear-Desktop / Front-Ceiling / Rear-Ceiling	
	Menu Location		Top Left / Top Right / Center / Bottom Left / Bottom Right	
	Lens Function	Zoom		Lock / Unlock
		Focus		Lock / Unlock
		Lens Shift		Lock / Unlock
		Lens Position		Set 1 / Set 2 / Set 3
		Lens Calibration		Yes / No
		Exit		
	Security	Security Timer		Month / Day / Hour / Exit
		Change Password		
		Security		On / Off
		Exit		
	Signal (RGB)	Frequency		
		Phase		
		H. Position		
		V. Position		
		Automatic		Enable / Disable
		Exit		
	Signal (Video)	White Level		
		Black Level		
		Saturation		
IRE				
Exit				
	Projector No			

Main Menu	Sub Menu	Settings	
SETTING	Audio Settings	Internal Speaker On / Off	
		Mute On / Off	
		Volume	
		Exit	
	Advanced	Logo Viewsonic / Neutral / User	
		Logo Capture On / Off	
		Closed Captioning CC1 / CC2 / CC3 / CC4 / Off	
		Exit	
	Network	Network State	
		DHCP	
		IP Address	
		Subnet Mask	
		Gateway	
		DNS	
		Apply	
		Control System IP Address	
		Control System IP ID	
		Control System Port	
		Exit	
		Image Blending	Blending On / Off
			Crop On / Off
	Overlap Left Start / Left End / Right Start / Right End / Up Start / Up End / Down Start / Down End		
	Bright Adj. Overlap / Non Overlap		
	Gamma 1.8 / 2.0 / 2.2 / 2.6		

Main Menu	Sub Menu	Settings	
OPTIONS	Auto Source	On / Off	
	High Altitude	On / Off	
	Status Hide	On / Off	
	Keypad Lock	Lock / Unlock	
	Test Pattern	None / Grid / White	
	Background Color	Blue / Black / Red / Green / White	
	Lamp Settings	Lamp Hour	
		Lamp Reminder	On / Off
		Lamp Mode	Normal / ECO / Power
		Lamp Reset	Yes / No
	Remote Settings	Exit	
		My Button	BrilliantColor / Gamma / DynamicBlack / Color Temp. / Projection / Projector ID / HDMI Cable
		Top IR Function	On / Off
		Front IR Function	On / Off
		Remote Code	
	12V Trigger	Exit	
	Advanced	12V Trigger	On / Off
		Direct Power On	On / Off
		Auto Power Off	
		Sleep Timer	
		Standby Mode	LAN On / LAN Off
		Baudrate	9600/19200/38400
	HDMI Cable	Exit	
	Information	Normal / Long / Short	
	Reset	Yes / No	

PICTURE

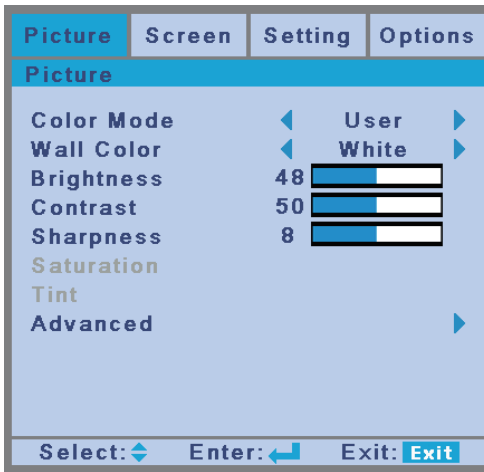

Color Mode

There are many factory presets optimized for various types of images.

- ▶ Presentation: Good color and brightness from PC input.
- ▶ Bright: Maximum brightness from PC input.
- ▶ Movie: For home theater.

NOTE

■ The Pro10 Series use **Dynamic Color Wheel** technology, so screen flickering when you change between color modes is normal.

- ▶ sRGB: Standardised accurate color.
- ▶ DICOM SIM.: This display mode simulates the greyscale/gamma performance of equipment used for “Digital Imaging and Communications in Medicine” (DICOM).

IMPORTANT: This mode should NEVER be used for medical diagnosis, it is for education/training purposes only.

- ▶ User: User’s settings.

Wall Color

Select a similar preset color of the colored wall, in order to correct the color of the projected image as if it is projected on a white screen.

Available options: White / Light Yellow / Light Blue / Pink / Dark Green.

Brightness

Adjust the brightness of the image.

- ▶ Press the ◀ button to darken image.
- ▶ Press the ▶ button to lighten the image.

Contrast

The contrast controls the degree of difference between the lightest and the darkest parts of the picture. Adjusting the contrast changes the amount of black and white in the image.

- ▶ Press the ◀ button to decrease the contrast.
- ▶ Press the ▶ button to increase the contrast.

Sharpness

Adjust the sharpness of the image.

- ▶ Press the ◀ button to decrease the sharpness.
- ▶ Press the ▶ button to increase the sharpness.

Saturation

Adjust a video image from black and white to fully saturated color.

- ▶ Press the ◀ button to decrease the color saturation in the image.
- ▶ Press the ▶ to increase the color saturation in the image.

Tint

Adjust the color balance of red and green.

- ▶ Press the ◀ button to increase the amount of green in the image.
- ▶ Press the ▶ button to increase the amount of red in the image.

NOTE

- *"Color" and "Tint" are only supported for composite and component sources.*

PICTURE | Advanced

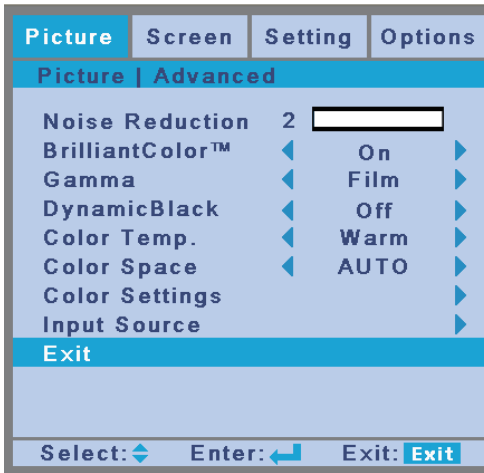

Noise Reduction

The motion Adaptive Noise Reduction reduces the amount of visible noise interlaced signals. The range is from “0” to “10”. (0: Off)

BrilliantColor™

Enable the BrilliantColor™ function to enhance the brightness while providing true, more vibrant colors in picture.

Gamma

This allows you to choose a gamma table that has been finetuned to bring out the best image quality for the input.

- ▶ Film: for home theater.
- ▶ Video: for video or TV source.
- ▶ Graphics: for image source.
- ▶ Standard: for standardized setting.

DynamicBlack

DynamicBlack enables the projector to automatically optimize the display of dark movie scenes enabling them to be shown in incredible detail.



- *The **DynamicBlack** function by default is set to **OFF**. To turn it **ON**, go to **OSD Menu > PICTURE > Advanced**. However, if display image flickering leaves some viewers uncomfortable, turn it off for the better viewing.*

Color Temp.

If set to cold temperature, the image looks more blueish (cold image). If set to warm temperature, the image looks more reddish (warm image).

Color Space

Select an appropriate color matrix type from AUTO, RGB, RGB(0-255), RGB(16-235) or YUV.

NOTE

- "RGB(0-255)" and "RGB(16-235)" are only supported for HDMI source.

Color Settings

Press **←** into the next menu and then use **▲** or **▼** to select item.

- ▶ Red Gain/Green Gain/Blue Gain/Red Bias/Green Bias/Blue Bias: Use **◀** or **▶** to Red, Green, or Blue for brightness (Gain) and contrast (Bias).
- ▶ Reset: Choose "Yes" to return the factory default settings for color adjustments.

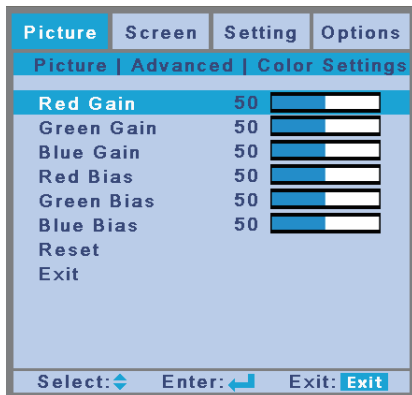

Input Source

Use this option to enable / disable input sources. Press **←** to enter the sub menu and select which sources you require. Press "Enter" to finalize the selection. The projector will not search for inputs that are not selected.

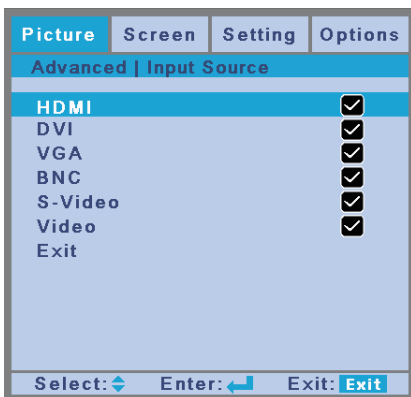

SCREEN

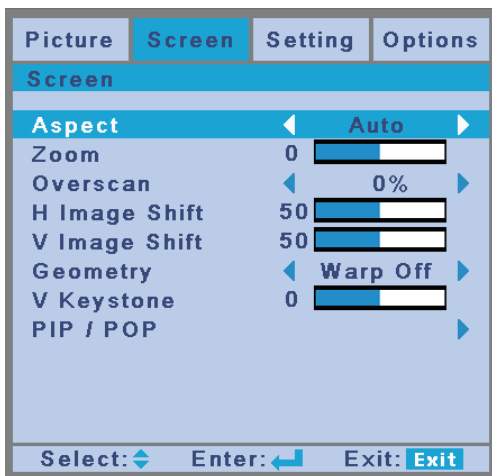

Aspect

Use this function to choose your desired aspect ratio.

- ▶ 4:3: This format is for 4x3 input sources.
- ▶ 16:9: This format is for 16x9 input sources, like HDTV and DVD enhanced for Wide screen TV.
- ▶ Native: This format displays the original image without any scaling.
- ▶ Auto: Automatically selects the appropriate display format.

Zoom

- ▶ Press the ◀ button to reduce the size of an image.
- ▶ Press the ▶ button to magnify an image on the projection screen.

Overscan

Overscan function removes the noise in a video image. Overscan the image to remove video encoding noise on the edge of video source.



- Each I/O has different settings of "Overscan".
- "Overscan" and "Zoom" can't work at same time.

H Image Shift

Shift the projected image position horizontally.

V Image Shift

Shift the projected image position vertically.

V Keystone

Press the ◀ or ▶ to adjust image distortion vertically and make a squarer image.

SCREEN | Geometry

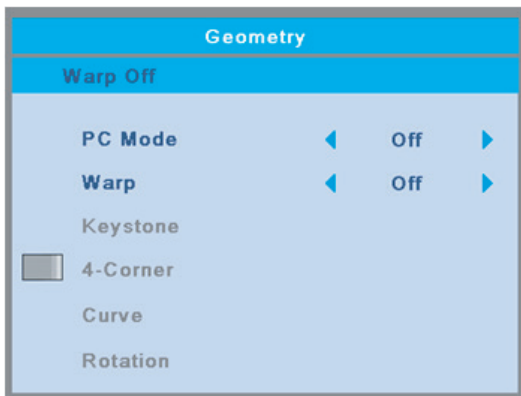

PC Mode

Enable RJ45 control with PC software that allows user to control geometry.

Warp

Enable the Geometry function and control by OSD.

Keystone

This allows you to correct the keystone distortion.

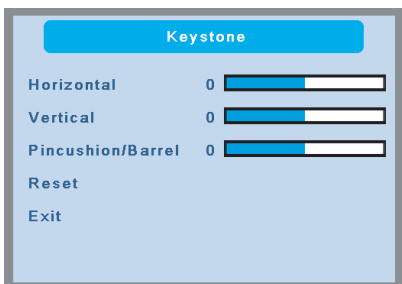

- ▶ Horizontal: Press the ◀ or ▶ to adjust the keystone horizontally and make a squarer image.
- ▶ Vertical: Press the ◀ or ▶ to adjust the keystone vertically and make a squarer image.

Resolution	Degrees of keystone Correction	
	Horizontal	Vertical
XGA	+/- 40	+/- 40

- ▶ Pin Cushion/Barrel: Press the ◀ or ▶ to adjust the pincushion/barrel distortion. +/- 20% pincushion and barrel distortion correction.

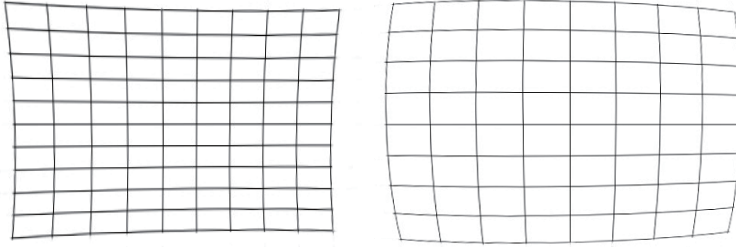

- ▶ Reset: Return to the default setting.

4-Corner

This allows you to correct the trapezoidal distortion.

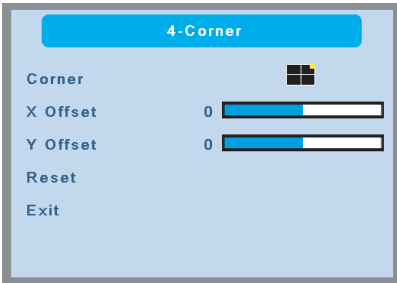

- ▶ 4 Corner position adjustments: Top Left, Bottom Left, Top Right, Bottom Right and All. Maximum is 5%.
- ▶ Press the ◀ or ▶ to adjust x/y offset of each corner image.

Curve

This allows you to adjust the curve of point 1~9.

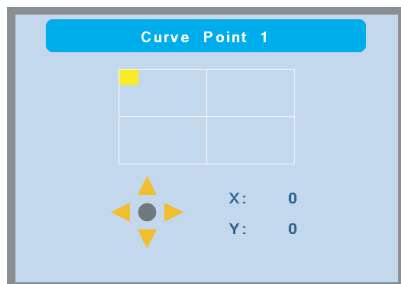
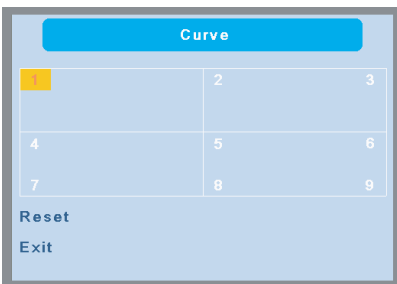

- ▶ The screen is separated into 4 (2x2) grids and you can adjust every point of grids.



Rotation

This allows you to level the rotated image.

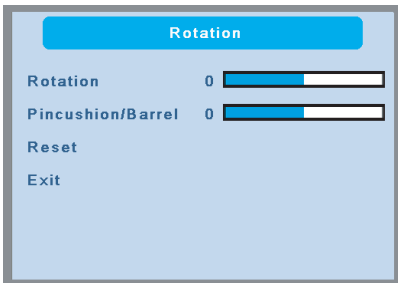

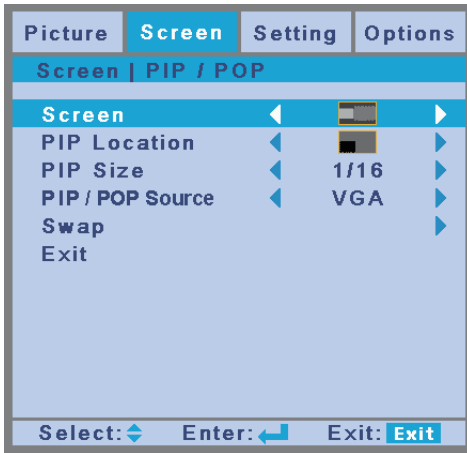

- ▶ Rotation: Press the ◀ or ▶ to adjust the angle of image. Rotation angles can reach to +/- 90 degree.
- ▶ Pin Cushion/Barrel: Press the ◀ or ▶ to adjust the pincushion/barrel distortion. +/- 20% pincushion and barrel distortion correction.
- ▶ Reset: Return to the default setting.

SCREEN | PIP / POP



Screen

- ▶  Single Screen: Projection single window.
- ▶  PIP Screen: Main source is at large window; PIP source is at small window and displays in the corner of the main window.
- ▶  POP Screen: Main source is at the left window and POP source is at the right window, they are equal sizes and side by side.

PIP Location

Choose the PIP screen position on the display screen.

PIP Size

Choose the PIP size from 1/16, 1/25 or 1/36 on the display screen.

PIP / POP Source

Choose the source to switch PIP/POP window source.

Swap

Press to swap the sources of main window and PIP/POP window.

Some source/signal combinations may not be compatible with PIP/POP function.

Please refer to the table below:

PIP/POP source	Main Source					
	HDMI	VGA	DVI-D	BNC	S-video	Video
HDMI			V	V	V	V
VGA			V	V	V	V
DVI-D	V	V				
BNC	V	V				
S-video	V	V				
Video	V	V				

NOTE: VGA and BNC can support Component.

SETTING

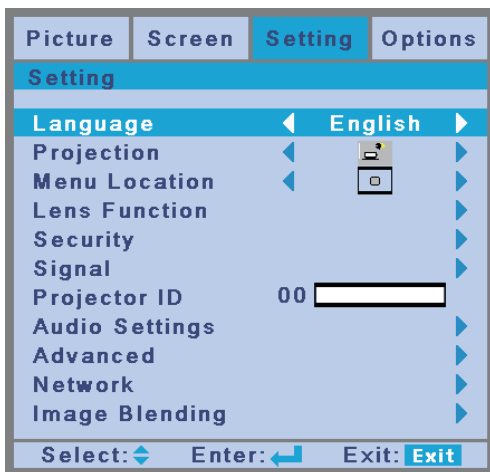





Language

Choose the multilingual OSD menu. Press ◀ or ▶ into the sub menu and then use the ▲ or ▼ to select your preferred language. Press “Enter” to finalize the selection.



Projection

- ▶  Front-Desktop
This is the default selection. The image is projected straight on the screen.
- ▶  Rear-Desktop
When selected, the image will appear reversed.
- ▶  Front-Ceiling
When selected, the image will turn upside down.
- ▶  Rear-Ceiling
When selected, the image will appear reversed in upside down position.



■ Rear-Desktop and Rear-Ceiling are to be used with a translucent screen.

Menu Location

Choose the menu location on the display screen.

SETTING | Lens Function

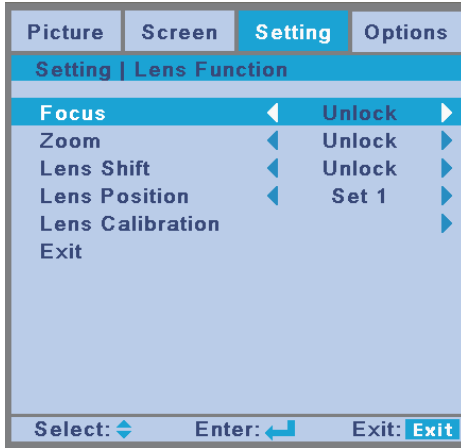

Focus

Adjust focus function on the projected image.

Zoom

Adjust zoom function on the projected image.

Lens Shift

Shift the projected image.

- ▶ Lock: This function can not be used by user.
- ▶ Unlock: This function can be used by user.

Lens Calibration

Perform calibration and return lens to the center position.

SETTING | Security

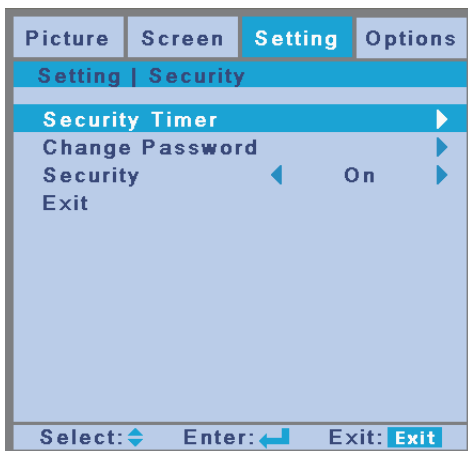

Security Timer

Use this function to set the how long (Month/Day/Hour) the projector can be used. Once this time has elapsed you will be requested to enter your password again.

Change Password

- ▶ First time:
 1. Press “←” to set the password.
 2. The password has to be 4 digits.
 3. Use number button on the remote to enter your new password and then press “←” key to confirm your password.
- ▶ Change Password:
 1. Press “←” to input old password.
 2. Use number button to enter current password and then press “←” to confirm.
 3. Enter new password (4 digits in length) using the number buttons on the remote, then press “←” to confirm.
 4. Enter new password again and press “←” to confirm.
- ▶ If the incorrect password is entered 3 times, the projector will automatically shut down.
- ▶ If you have forgotten your password, please contact your local office for support.

NOTE

- Password default value is “1234” (first time).
- Always keep the password in your files. If the password is forgotten or lost, please contact your local authorized service center.



Security

- ▶ On: Choose “On” to use security verification when turning on projector.
- ▶ Off: Choose “Off” to be able to switch on the projector without password verification.

SETTING | Signal (RGB)

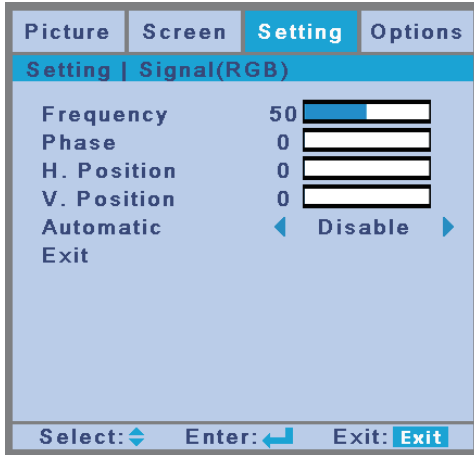

- *Signal is supported except Video and S-Video.*

Frequency

Change the display data frequency to match the frequency of your computer's graphic card. Use this function only if the image appears to flicker vertically.

Phase

Synchronize the signal timing of the display with the graphic card. If the image appears to be unstable or flickers, use this function to correct it.

H. Position

- ▶ Press the ◀ to move the image left.
- ▶ Press the ▶ to move the image right.

V. Position

- ▶ Press the ◀ to move the image down.
- ▶ Press the ▶ to move the image up.

Automatic

Automatically detects the signal. If you use this function, the phase, frequency items are grayed out, and if signal is not automatic, the phase, frequency items will appear for user to manually tune and saved in settings after that for next time projector turns off and on again.

SETTING | Signal (Video)

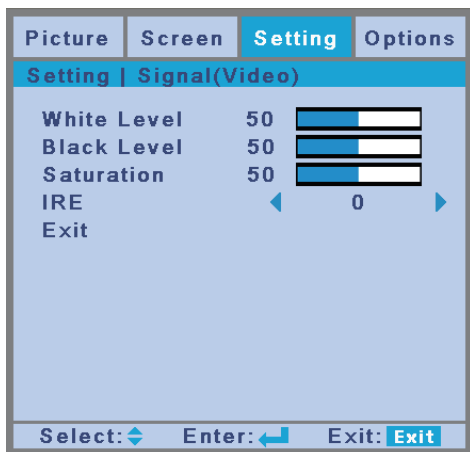

- "Signal" is only supported when the source is Video or S-video.

White Level

Allow user adjust White Level when inputting S-Video or Video signals.

Black Level

Allow user adjust Black Level when inputting S-Video or Video signals.

Saturation

Adjust a video image from black and white to fully saturated color.

- ▶ Press the ◀ to decrease the amount of saturation in the image.
- ▶ Press the ▶ to increase the amount of saturation in the image.

IRE

Adjust measurement of composite video signals.



- "IRE" is only supported on NTSC signal.

Projector ID

ID definition can be set up by menu (range 0-99) to indicate an individual projector.

SETTING | Audio Settings

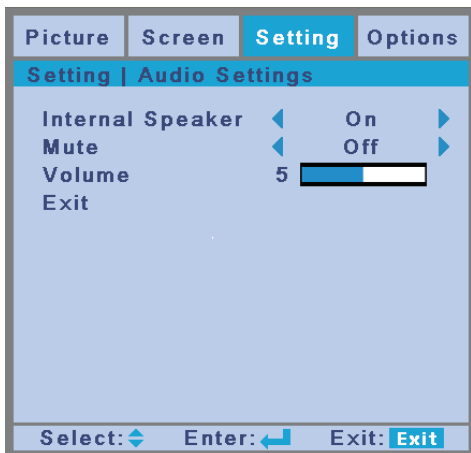

Internal Speaker

Choose the "On" or "Off" to turn on or off the internal speaker.

Mute

- ▶ Choose the "On" to turn mute on.
- ▶ Choose the "Off" to turn mute off.

Volume

- ▶ Press the ◀ to decrease the volume.
- ▶ Press the ▶ to increase the volume.

SETTING | Advanced

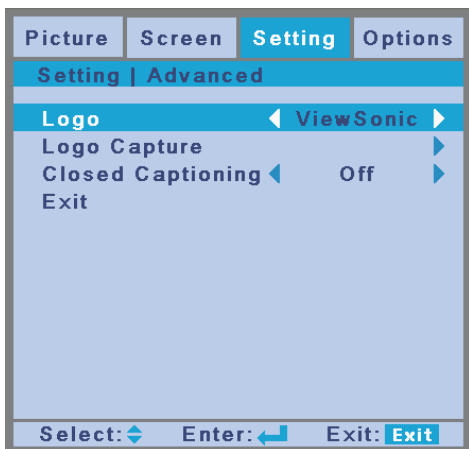

Logo

Use this function to set the desired startup screen. If changes are made they will take effect the next time the projector is powered on.

- ▶ Viewsonic: The default startup screen.
- ▶ Neutral: Logo is not displayed on startup screen.
- ▶ User: Use stored picture from “Logo Capture” function.

Logo Capture

Press **←** to capture an image of the picture currently displayed on screen.

Closed Captioning

If changes are made they will take effect the next time the projector is powered on.

- ▶ Off: select “off” to turn off the closed captioning feature.
- ▶ CC1: CC1 language: American English.
- ▶ CC2/CC3/CC4: CC2/CC3/CC4 language (depending on the TV channel of the user): Spanish, French, Portuguese, German, Danish.

SETTING | Network



Network State

Display the network connection status.

DHCP

Use this function to select your desired startup screen. If you change the setting from one to another, when you exit the OSD menu, the new setting will take effect on next open.

- ▶ On: Assign an IP address to the projector from an external DHCP server automatically.

When making a connection in the local area network.

1. Connect the computer and the projector to your network.
2. Press the 'menu' key in the remote controller.
3. Select Setting -> Network -> DHCP (as following).



4. DHCP mode selects 'On.'

If IP Address is 0.0.0.0, please check the connection and try again.

If still can not get the IP Address, please contact your network administrator.

- ▶ Off: Assign an IP address manually.

IP Address

Select an IP address.

Subnet Mask

Select subnet mask number.

Gateway

Select the default gateway of the network connected to the projector.

DNS

Select DNS number.

Apply

Press “←” and then choose “Yes” to apply the selection.



- *All of the new settings of the non-DHCP mode shall be triggered by “Yes”.*

Control System IP Address

Select an IP address for Crestron Control System.

Control System IP ID

Select an IP ID for Crestron Control System.

Control System Port

Select a connection port for Crestron Control System.

Crestron RoomView Control Tool

Crestron RoomView™ provides a central monitoring station for 250+ control systems on a single Ethernet network (more are possible, the number depends on the combination of IP ID and IP address). Crestron RoomView monitors each projector, including projector's online status, system power, lamp life, network setting and hardware faults, plus any custom attribute as defined by the Administrator.

The Administrator can add, delete, or edit room information, contact information and events, which are logged automatically by the software for all users. (Operation UI as following image)

 ■ *Crestron RoomView function support is dependent on models.*

1. Main Screen

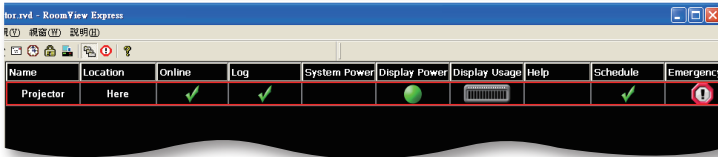

2. Edit Room

On the “Edit Room” page, enter the IP Address (or hostname) as shown on the projector’s on-screen display (OSD) menu, and “02” for IPID, “41794” for the reserved Crestron control port.

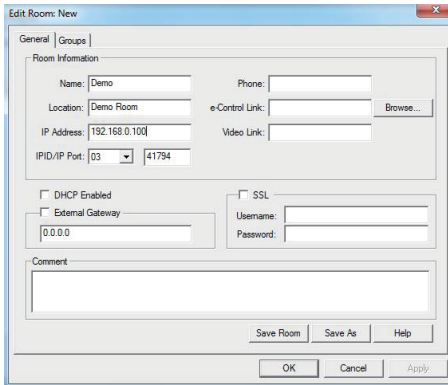

About Crestron RoomView™ setting and command method, please access below website to get RoomView™ User Guide and more information:
http://www.crestron.com/products/roomview_connected_embedded_projectors_devices/resources.asp

3. Edit Attribute

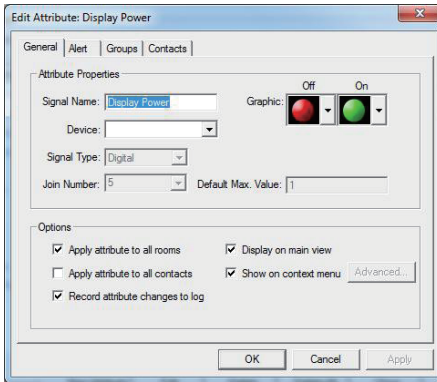

4. Edit Event

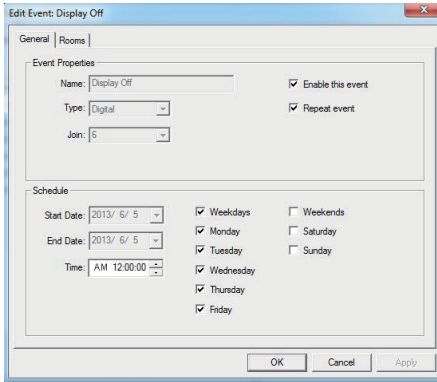

***For more information, please visit
<http://www.crestron.com> & www.crestron.com/getroomview.***

Network supports Crestron (Room View), AMX (Device Discovery Beacon Validation Tool) , PJLink and RS232 control.

SETTING | Image Blending

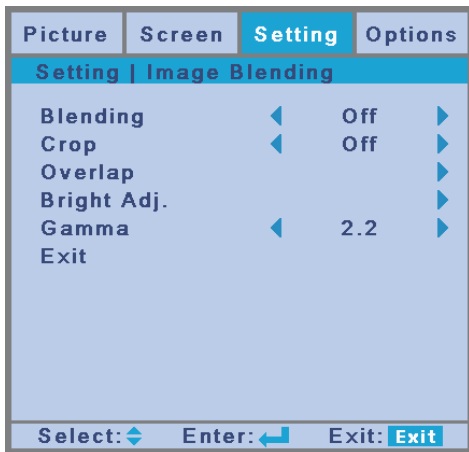

Blending

- ▶ Choose the “On” to turn blending on.
- ▶ Choose the “Off” to turn blending off.

Crop

- ▶ Choose the “On” to turn crop on.
- ▶ Choose the “Off” to turn crop off.

Overlap

This allows you to set the overlap edge of blending area.

Bright Adj.

This allows you to adjust the brightness of the blending area.

Gamma

This allows you to select the gamma mode.

OPTIONS

Picture	Screen	Setting	Options
Options			
Auto Source	◀	Off	▶
High Altitude	◀	Off	▶
Status Hide	◀	Off	▶
Keypad Lock	◀	Unlock	▶
Test Pattern			▶
Background Color	◀	Blue	▶
Lamp Settings			▶
Remote Settings			▶
12V Trigger	◀	Off	▶
Advanced			▶
HDMI Cable	◀	Normal	▶
Select: ◀▶	Enter: ◀▶	Exit: Exit	

Auto Source

- ▶ On: The projector will only search current input connection.
- ▶ Off: The projector will search for other signals if the current input signal is lost.



- Press direct source key on remote controller, it will change source directly and automatically set the Source Lock to "ON".
- To turn off the keypad lock, press and hold "Enter" key on top of the projector for 5 seconds.

High Altitude

When "On" is selected, the fans will spin faster. This feature is useful in high altitude areas where the air is thin.

Status Hide

- ▶ On: Choose "On" to hide the info message.
- ▶ Off: Choose "Off" to show the "searching" message.

Keypad Lock

When the keypad lock function is "On", the control panel will be locked however, the projector can be operated by the remote control. By selecting "Off", you will be able to reuse the control panel.

Test Pattern

Display a test pattern. There are Grid, White and None.

Background Color

Use this feature to display a "Blue", "Black", "Red", "Green", or "White" screen when no signal is available.

OPTIONS (Continue)

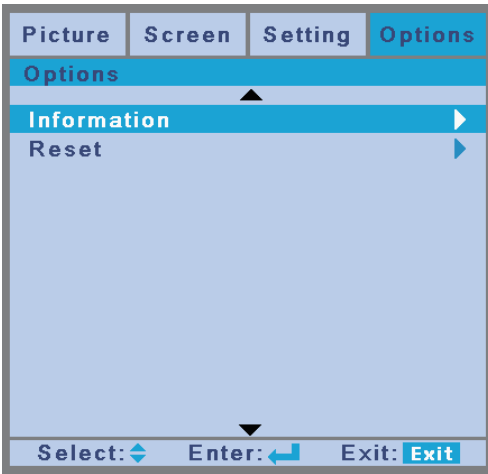

12V Trigger

12V trigger provides a standard trigger for motorized screens.

HDMI Cable

Specify the HDMI cable length. Available options: Normal / Long / Short.

Information

Display the projector information for source, resolution, and software version on the screen.

The screenshot shows the projector's 'Information' screen. The title 'Information' is at the top in a blue bar. Below it, the following information is displayed:

Current Source: Video	
NTSC	
Signal	
White Level	0
Black Level	0
Saturation	50
IRE	0
Logo	ViewSonic
Lamp Setting	
Lamp Reminder	Off
Lamp Mode	Normal
High Altitude	Off
Projector ID	00
Remote Code	00
Remote Code (Active)	N/A
IP Address	192.168.0.100
SN:	N/A

- Remote code: show the remote code of the projector.
- Remote code(Active): show the remote code of the remote control.

Reset

Choose “Yes” to return the display parameters on all menus to the factory default settings.

The following settings will still remain: Phase, H. Size, User, Language, Projector Position, High Altitude Mode, Security Settings, and Keystone.

OPTIONS | Lamp Settings

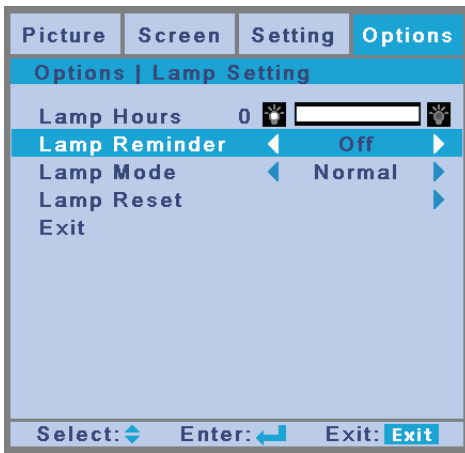

Lamp Hours

Display the projection time.

Lamp Reminder

Choose this function to show or to hide the warning message when the changing lamp message is displayed.

The message will appear 30 hours before suggested replacement of lamp.

Lamp Mode

- ▶ Normal: Choose “Normal” to increase the brightness.
- ▶ ECO: Choose “ECO” to dim the projector lamp which will lower power consumption and extend the lamp life.
- ▶ Power: Power improves the contrast of the picture by optimizing the brightness of the lamp according to the picture content.

Lamp Reset

Reset the lamp hour counter after replacing the lamp.

OPTIONS | Remote Settings

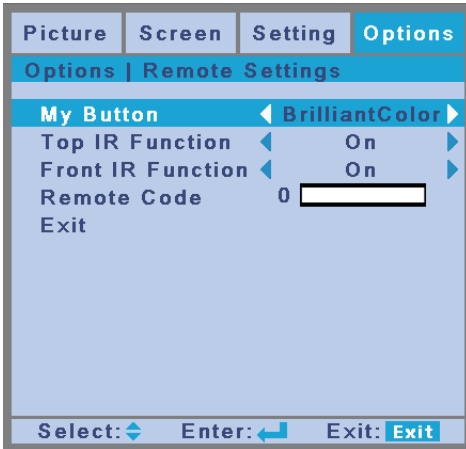

My Button

Choose your desired function from "BrilliantColor", "Gamma", "DynamicBlack", "Color Temp.", "Projection", "Projector ID" or "HDMI Cable".

Top IR Function

When this function is "On", the projector can be operated by the remote control from top IR receiver.

By selecting "Off", you will be able to use the control panel keys or operate by the remote control from front IR receiver.

Front IR Function

When this function is "On", the projector can be operated by the remote control from front IR receiver.

By selecting "Off", you will be able to use the control panel keys or operate by the remote control from top IR receiver.

Remote Code

Set remote code of the projector.

- ▶ Default code (common code): 00
- ▶ Remote code: 01 ~ 99

OPTIONS | Advanced

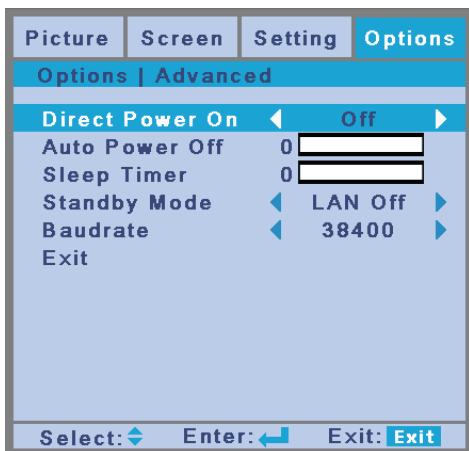

Direct Power On

Choose “On” to activate Direct Power mode. The projector will automatically power on when AC power is supplied, without pressing the “**O**” key on the projector control panel or on the remote control.

Auto Power Off

Sets the countdown timer interval. The countdown timer will start, when there is no signal being sent to the projector. The projector will automatically power off when the countdown has finished (in minutes).

Sleep Timer

Sets the countdown timer interval. The countdown timer will start, with or without a signal being sent to the projector. The projector will automatically power off when the countdown has finished (in minutes).

Standby Mode

- ▶ LAN On: Choose “LAN On” when you control the projector via the LAN terminal during power standby.
- ▶ LAN Off: Choose “LAN Off” to disable the LAN terminal and reduces the power consumption during the power standby.

Baudrate

Select RS232 baudrate from “9600”, “19200”, or “38400”.

Appendices

Troubleshooting

If you experience a problem with your projector, please refer to the following information. If a problem persists, please contact your local reseller or service center.

Image Problems

? No image appears on-screen

- ▶ Ensure all the cables and power connections are correctly and securely connected as described in the “Installation” section.
- ▶ Ensure the pins of connectors are not crooked or broken.
- ▶ Check if the projection lamp has been securely installed.
- ▶ Make sure you have removed the lens cover and the projector is switched on.

? Partial, scrolling or incorrectly displayed image

- ▶ Press "SYNC" on the control panel or the remote control.
- ▶ If you are using a PC:
 - For Windows 95, 98, 2000, XP, Windows 7:
 1. Open the “My Computer” icon, the “Control Panel” folder, and then double click on the “Display” icon.
 2. Select the “Settings” tab.
 3. Verify that your display resolution setting is lower than or equal to UXGA (1600 x 1200).
 4. Click on the “Advanced Properties”.

If the projector is still not projecting the whole image, you will also need to change the monitor display you are using. Refer to the following steps.

1. Verify the resolution setting is lower than or equal to UXGA (1600 x 1200).
2. Select the “Change” button under the “Monitor” tab.
3. Click on “Show all devices”. Next, select “Standard monitor types” under the SP box; choose the resolution mode you need under the “Models” box.
4. Verify that the resolution setting of the monitor display is lower than or equal to UXGA (1600 x 1200).

- ▶ If you are using a Notebook:
 - First, follow the steps above to adjust resolution of the computer.
 - Press the toggle output settings. example: [Fn]+[F4]

Notebook Brand	Function Keys
Acer	[Fn]+[F5]
Asus	[Fn]+[F8]
Dell	[Fn]+[F8]
Gateway	[Fn]+[F4]
IBM/Lenovo	[Fn]+[F7]
HP/Compaq	[Fn]+[F4]
NEC	[Fn]+[F3]
Toshiba	[Fn]+[F5]
Mac Apple	System Preference -> Display -> Arrangement -> Mirror display

- ▶ If you experience difficulty changing resolutions or your monitor freezes, restart all equipment including the projector.

? The screen of the Notebook or PowerBook computer is not displaying your presentation

Some Notebook PCs may deactivate their own screens when a second display device is in use. Each has a different way to be reactivated. Refer to your computer’s documentation for detailed information.

? Image is unstable or flickering

- ▶ Adjust the “Phase” to correct it.
- ▶ Change the monitor color setting from your computer.

? **Image has vertical flickering bar**

- ▶ Use “Frequency” to make an adjustment.
- ▶ Check and reconfigure the display mode of your graphic card to make it compatible with the projector.

? **Image is out of focus**

- ▶ Make sure the lens cover is removed.
- ▶ Adjust the Focus function for the projector lens.
- ▶ Make sure the projection screen is between the required distance.

? **The image is stretched when displaying 16:9 DVD title**

- ▶ When you play anamorphic DVD or 16:9 DVD, the projector will show the best image when the projector display mode is set to 16:9 in the OSD.
- ▶ If you play 4:3 format DVD titles, please change the format to 4:3 in the projector OSD.
- ▶ If the image is still stretched, you will also need to adjust the aspect ratio by referring to the following:
- ▶ Please setup the display format as 16:9 (wide) aspect ratio type on your DVD player.

? **Image is too small or too large**

- ▶ Move the projector closer to or further from the screen.
- ▶ Press “Menu” on the control panel. Go to “SCREEN” --> “Aspect” and try the different settings.

? **Image has slanted sides:**

- ▶ If possible, reposition the projector so that it is centered on the screen and below the bottom of the screen.
- ▶ Press the "Keystone" button on the remote control, until the sides are vertical.

? **Image is reversed**

- ▶ Adjust the “SETTING” --> “Projection” to correct it.

Projector Problems

? The projector stops responding to all controls

- ▶ If possible, turn off the projector, then unplug the power cord and wait at least 60 seconds before reconnecting power.
- ▶ Check that “Keypad Lock” is not activated by trying to control the projector with the remote control.

? Lamp burns out or makes a popping sound

- ▶ When the lamp reaches its end of life, it will burn out and may make a loud popping sound. If this happens, the projector will not turn on until the lamp module has been replaced. To replace the lamp, follow the procedures in the “Replacing the Lamp” section.

? If the remote control does not work

- ▶ Check if the operating angle of the remote control is within $\pm 30^\circ$ both horizontally and vertically on one of the IR receivers on the projector.
- ▶ Make sure there is no obstruction between the remote control and the projector. Move to within 12 m ($\pm 0^\circ$) of the projector.
- ▶ Make sure the batteries are inserted correctly.
- ▶ Replace batteries if they are exhausted.
- ▶ Ensure that you have set your remote to the correct IR code setting.

? When making a direct connection from your computer to the projector

- ▶ If you have network connection problem from your computer to the projector, please refer to the computer setting as below or contact with web administrator.

Step 1: Find an IP Address (192.168.0.100) from LAN function of projector.



Step 2: Select “Apply” and push the “Enter” button. Once the setting is saved, exit the OSD by pushing “Menu” button.

Step 3: To open Network Connections, click **Start**, click **Control Panel**, click **Network and Internet Connections**, and then click **Network Connections**. Click the connection you want to configure, and then, under **Network Tasks** , click **Change settings of this connection**.

Step 4: On the **General** tab, under **This connection use the following items**, click Internet Protocol(TCP/IP), and then click “**Properties**”.

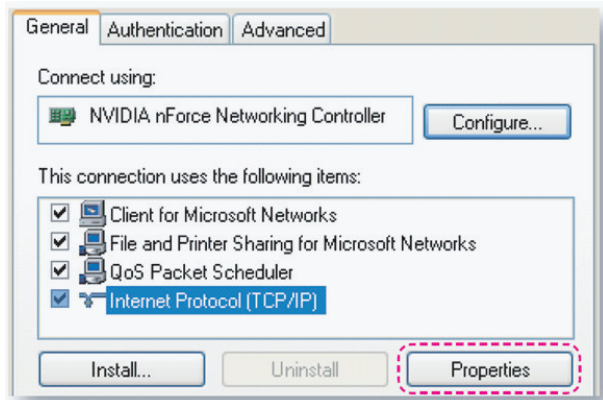

Step 5: Click **Use the following IP address**, and type in as below:

- 1) IP address: 192.168.0.101
- 2) Subnet mask: 255.255.255.0
- 3) Default gateway: 192.168.0.254

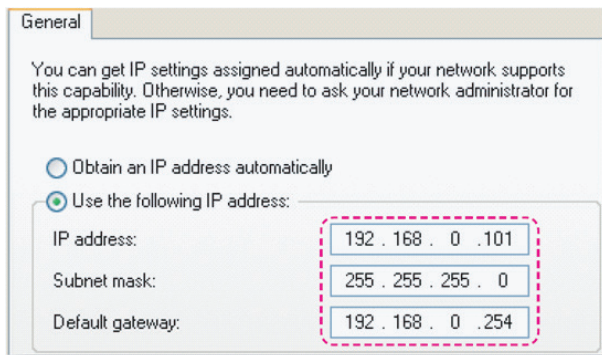

Step 6: To open Internet Options, click IE web browser, click Internet Options, click the **Connections** tab and click “**LAN Setting...**”.

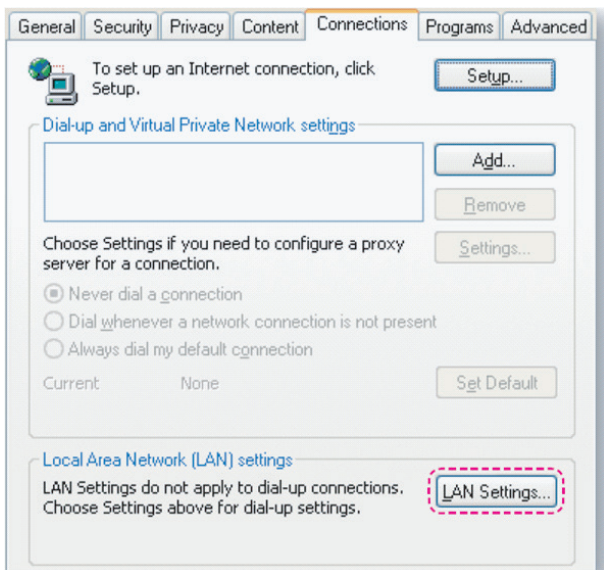

Step 7: All items in the **Local Area Network (LAN) Setting** window must unchecked. Then click “OK” button twice.

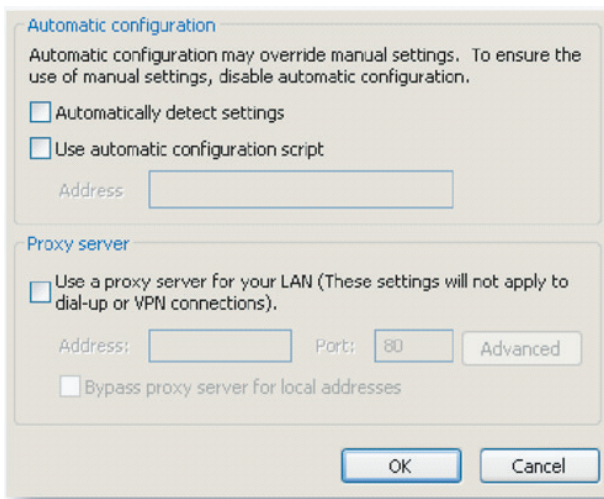

Step 8: Connect a cat5 Ethernet cross-over cable between the projector and the computer.

On Screen Messages

- Power off confirm

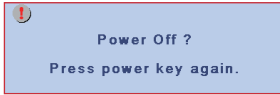

- Lamp error



- Lamp Life warning

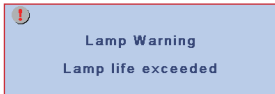

- Filter error

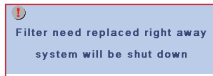

Replacing the Lamp

A warning message will be displayed once the lamp has surpassed life expectancy.



Lamp Warning
Lamp life exceeded

At this point, it is recommended to change the lamp as soon as possible. Please contact your local reseller or ViewSonic to acquire a lamp.

Type number: RLC-087

   **CAUTION!**

HIGH PRESSURE LAMP MAY EXPLODE IF IMPROPERLY HANDED. REFER TO LAMP REPLACEMENT INSTRUCTIONS.

ATTENTION:

Les lampes à haute pression peuvent exploser si elles sont mal utilisées.

Confier l'entretien à une personne qualifiée.



Warning: If ceiling mounted, please use caution when opening the lamp access panel. It is recommended to wear safety glasses if changing the bulb when ceiling mounted. "Caution must be used to prevent any loose parts from falling out of projector."



Warning: Lamp compartment is hot! Allow it to cool down before changing lamp!



Warning: To reduce the risk of personal injury, do not drop the lamp module or touch the lamp bulb. The bulb may shatter and cause injury if it is dropped.

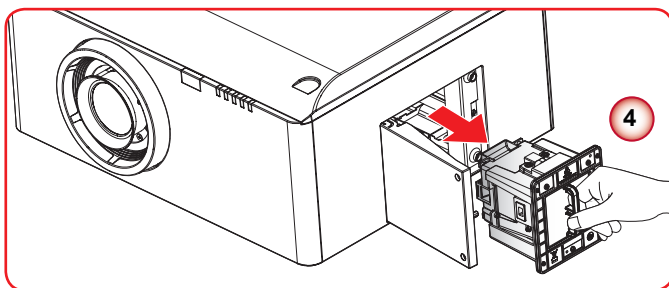
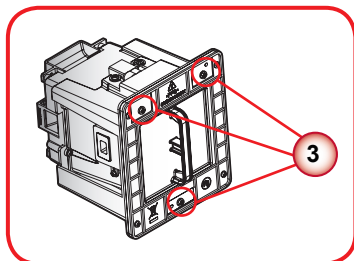
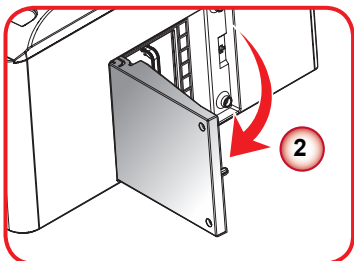
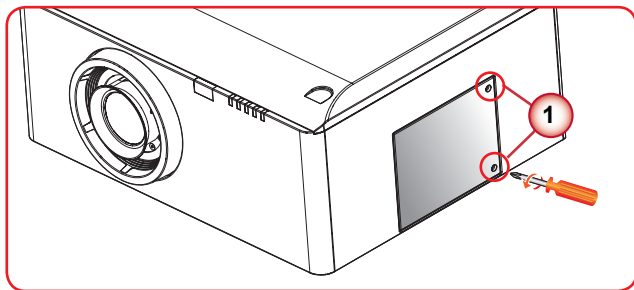

Lamp Replacing Procedure:

1. Switch off the power to the projector by pressing the “⏻” button.
2. Allow the projector to cool down for at least 30 minutes.
3. Disconnect the power cord.
4. Unscrew the two screws on the lamp door. **1**
5. Open and pull up the lamp door. **2**
6. Unscrew the three screws on the lamp housing. **3**
7. Pull out the lamp module slowly and carefully. **4**

To replace the lamp module, reverse the previous steps.

8. Turn on the projector and use “Lamp Reset” after the lamp module is replaced.

Lamp Reset: (i) Press “Menu” → (ii) Select “OPTIONS” → (iii) Select “Lamp Settings” → (iv) Select “Lamp Reset” → (v) Select “Yes”.

Replacing the Filter

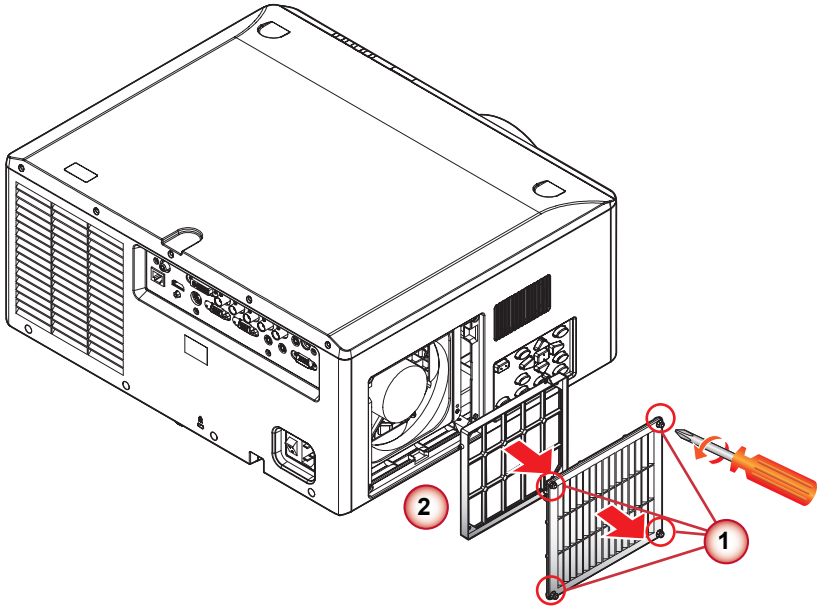

Filter Replacing Procedure:

1. Switch off the power to the projector by pressing the “” button.
2. Allow the projector to cool down for at least 30 minutes.
3. Disconnect the power cord.
4. Unscrew the four screws on the filter cover and pull out the cover. **1**
5. Remove the old filter and replace it with the new one. **2**
6. Attach the filter cover and secure it with the four included screws.

Compatibility Modes

▶ Computer Compatibility (PC)

Signal	Resolution	Frequency H. (KHz)	Refresh Rate (Hz)	Video	Digital	Analog	Remark
NTSC	-	15.734	60	○	-	-	
PAL/SECAM	-	15.625	50	○	-	-	
	640 x 350	31.5	70.1		○	○	70Hz
	640 x 400	37.9	85.1		○	○	85Hz
	720 x 400	31.5	70		○	○	
	720 x 400	37.9	85		○	○	
	720 x 576		50		○	○	
VGA	640 x 480	31.5	60		○	○	
VGA	640 x 480		67		○	○	
VGA	640 x 480	37.9	72.8		○	○	72Hz
VGA	640 x 480	37.5	75		○	○	
VGA	640 x 480	43.3	85		○	○	
SVGA	800 x 600	35.2	56.3		○	○	56Hz
SVGA	800 x 600	37.9	60.3		○	○	60Hz
SVGA	800 x 600	46.9	75		○	○	
SVGA	800 x 600	48.1	72.2		○	○	72Hz
SVGA	800 x 600	53.7	85.1		○	○	85Hz
	832 x 624		75		○	○	
XGA	1024 x 768	48.4	60		○	○	
XGA	1024 x 768	56.5	70.1		○	○	70Hz
XGA	1024 x 768	60	75		○	○	
XGA	1024 x 768	68.7	85		○	○	
	1152 x 864		75		○	○	
HD720	1280 x 720		50		○	○	
HD720	1280 x 720		60		○	○	
WXGA	1280 x 768	47.4	60		○	○	
WXGA	1280 x 768		75		○	○	
WXGA	1280 x 768		85		○	○	
WXGA-800	1280 x 800		60		○	○	
SXGA	1280 x 1024	64	60		○	○	
SXGA	1280 x 1024	80	75		○	○	
SXGA	1280 x 1024	91.1	85		○	○	
SXGA+	1400 x 1050		60		○	-	
UXGA	1600 x 1200	75	60		○	○	
HD1080	1920 x 1080		24		○	○	
HD1080	1920 x 1080		50		○	○	
HD1080	1920 x 1080		60		○	○	
WUXGA	1920 x 1200		60		○	○	Only support [RB] timing
HDTV	1920 x 1080	33.8	30	○	-	-	
	1920 x 1080	28.1	25	○	-	-	

Signal	Resolution	Frequency H. (KHz)	Refresh Rate (Hz)	Video	Digital	Analog	Remark
	1920 x 1080i		50	-	o	o	
	1920 x 1080i		60	-	o	o	
	1920 x 1080p		24	-	o	o	
	1920 x 1080p		25	-	o	o	
	1920 x 1080p		30	-	o	o	
	1920 x 1080p		50	-	o	o	
	1920 x 1080p		60	-	o	o	
	1280 x 720	45	60	o	-	-	
	1280 x 720p		50	-	o	o	
	1280 x 720p		60	-	o	o	
SDTV	720 x 576	31.3	50	o	-	-	
	720 x 576i		50	-	o	o	
	720 x 576p		50	-	o	o	
	720 x 480	31.5	60	o	-	-	
	720 x 480i		60	-	o	o	
	720 x 480p		60	-	o	o	

► Computer Compatibility for MAC

Resolution	Refresh Rate (Hz)	Macbook compatibility		Macbook Pro (Intel) compatibility		Power Mac G5 compatibility		Power Mac G4 compatibility	
		Digital	Analog	Digital	Analog	Digital	Analog	Digital	Analog
800x600	60	o	o	o	o	-	-	o	-
800x600	72	o	o	o	o	-	o	o	o
800x600	75	o	o	o	o	-	o	o	o
800x600	85	o	o	-	o	-	o	o	o
1024x768	60	o	o	o	o	-	o	o	o
1024x768	70	o	o	o	o	-	o	o	o
1024x768	75	o	o	o	o	-	o	o	o
1024x768	85	o	o	o	o	-	o	o	o
1280x720	60	o	o	o	o	-	o	o	o
1280x768	60	o	o	o	o	-	-	-	o
1280x768	75	-	o	-	o	-	o	o	o
1280x768	85	-	o	-	o	-	-	-	o
1280x800	60	-	o	-	o	-	o	o	o
1280x1024	60	o	-	-	o	-	o	o	o
1280x1024	75	o	-	-	o	-	o	o	-
1920x1080	60	o	-	-	o	-	o	o	o
1920x1200 (*1)	60	o	-	-	o	-	o	o	o



■ (*1) 1920 x 1200 @60hz only support RB(reduced blanking).

Remote Key Code

Default custom code => 83F4

Mode 01 ~ 99 => 8301 ~ 8399

Format => NEC

Key	Byte3	Byte4	Key	Byte3	Byte4
Sync(Auto Sync)	08	f7	Pattern	55	AA
Keystone	09	F6	My Button	56	A9
Up	0b	f4	HDMI	58	A7
Down	0c	f3	DVI	5A	A5
Left	0e	f1	BNC	5B	A4
Right	0f	f0	Focus	92	6D
Mode(Color Mode)	10	ef	Zoom	93	6C
Aspect	13	EC	Shift(Lens Shift)	94	6B
Mute	14	eb	Memory(Lens Shift Memory)	95	6A
Enter	15	ea	RC ID	96	69
Standby (Power Off)	16	E9	i (INFO)	97	68
Power On	17	E8	Reset (Default)	98	67
Exit	28	D7	RGB Gain(Color setting)	99	66
Menu	30	CF	Lamp PW (Lamp power)	9A	65
Source	40	bf	PIP	9B	64
VGA (PC)	41	be	Blend(Image blending)	9C	63
Video	52	ad	GEO (Geometry)	9D	62
S-Video	53	AC	Blank	07	f8

Remote operation

1. Under below conditions, the remote will enter “sleep mode” after 60 seconds.

- No button pressed
- Multi-keys pressed simultaneously
- One key pressed continuously over 60 seconds

2. Remote ID switching

Press “RC ID” key for 3 seconds to enter switching mode, the LED will flash slowly.

- Default ID, press “0” + “0”, ID will reset to default custom code (83F4), and this is a common code.
- Other ID, such as “01”, press “0” + “1”; ID range 00 ~ 99
 - If LED flash 3 times quickly, this means switching setup successfully;
 - No any setting within 10 seconds, remote will exit the switching mode and keep the original ID.

RS232 Pin Assignments

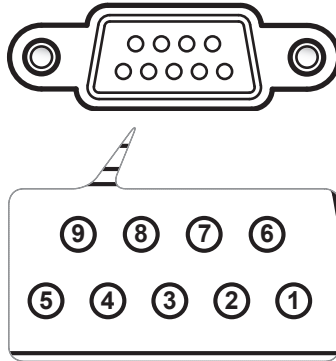

Pin No.	PC Side	Projector Side (RS232 Terminal)
1	N/A	N/A
2	RXD	RXD
3	TXD	TXD
4	N/A	N/A
5	GND	GND
6	N/A	N/A
7	N/A	N/A
8	N/A	N/A
9	N/A	N/A

Setup Information

RS-232 protocol	
Baud Rate	9600 bps (default)
Data Length	8 bit
Parity Check	None
Stop Bit	1 bit
Flow Control	None





- RS232 shell is grounded.
- RS232 interface need use swap pin for RS232 communication.

RS232 Protocol Function List

Main Menu	Sub Menu	Sub Menu 2	Sub Menu 3	Sub Menu 4	Value	RS232 Command	
PICTURE	Color Mode	Presentation			Presentation	0x06 0x14 0x00 0x04 0x00 0x34 0x12 0x0B 0x04 0x6D	
		Bright				0x06 0x14 0x00 0x04 0x00 0x34 0x12 0x0B 0x00 0x69	
		Movie				0x06 0x14 0x00 0x04 0x00 0x34 0x12 0x0B 0x01 0x6A	
		sRGB				0x06 0x14 0x00 0x04 0x00 0x34 0x12 0x0B 0x08 0x71	
		DICOM SIM.				0x06 0x14 0x00 0x04 0x00 0x34 0x12 0x0B 0x09 0x72	
		User				0x06 0x14 0x00 0x04 0x00 0x34 0x12 0x0B 0x02 0x6B	
		Read				0x07 0x14 0x00 0x05 0x00 0x34 0x00 0x00 0x12 0x0B 0x6A	
	Wall Color	White				0x06 0x14 0x00 0x04 0x00 0x34 0x12 0x0B 0x0A 0x73	
		Light Yellow				0x06 0x14 0x00 0x04 0x00 0x34 0x12 0x0B 0x0B 0x74	
		Light Blue				0x06 0x14 0x00 0x04 0x00 0x34 0x12 0x0B 0x0C 0x75	
		Pink				0x06 0x14 0x00 0x04 0x00 0x34 0x12 0x0B 0x0D 0x76	
		Dark Green				0x06 0x14 0x00 0x04 0x00 0x34 0x12 0x0B 0x0E 0x77	
	Brightness				-	0x06 0x14 0x00 0x04 0x00 0x34 0x12 0x02 0x00 0x61	
					+	0x06 0x14 0x00 0x04 0x00 0x34 0x12 0x03 0x01 0x62	
		Read				0x07 0x14 0x00 0x05 0x00 0x34 0x00 0x00 0x12 0x03 0x62	
	Contrast				-	0x06 0x14 0x00 0x04 0x00 0x34 0x12 0x02 0x00 0x60	
					+	0x06 0x14 0x00 0x04 0x00 0x34 0x12 0x02 0x01 0x61	
		Read				0x07 0x14 0x00 0x05 0x00 0x34 0x00 0x00 0x12 0x02 0x61	
	Sharpness				-	0x06 0x14 0x00 0x04 0x00 0x34 0x12 0x0E 0x00 0x6C	
					+	0x06 0x14 0x00 0x04 0x00 0x34 0x12 0x0E 0x01 0x6D	
		Read				0x07 0x14 0x00 0x05 0x00 0x34 0x00 0x00 0x12 0x0E 0x6D	
	Saturation				-	0x06 0x14 0x00 0x04 0x00 0x34 0x12 0x12 0x00 0x70	
					+	0x06 0x14 0x00 0x04 0x00 0x34 0x12 0x12 0x01 0x71	
		Read				0x07 0x14 0x00 0x05 0x00 0x34 0x00 0x00 0x12 0x12 0x71	
	Tint				-	0x06 0x14 0x00 0x04 0x00 0x34 0x12 0x11 0x00 0x6F	
					+	0x06 0x14 0x00 0x04 0x00 0x34 0x12 0x11 0x01 0x70	
		Read				0x07 0x14 0x00 0x05 0x00 0x34 0x00 0x00 0x12 0x11 0x70	
	Advanced	Noise Reduction				-	0x06 0x14 0x00 0x04 0x00 0x34 0x12 0x40 0x00 0x9E
						+	0x06 0x14 0x00 0x04 0x00 0x34 0x12 0x40 0x01 0x9F
			Read				0x07 0x14 0x00 0x05 0x00 0x34 0x00 0x00 0x12 0x40 0x9F
		BrilliantColor™	ON			On	0x06 0x14 0x00 0x04 0x00 0x34 0x11 0x03 0x01 0x61
			Off			Off	0x06 0x14 0x00 0x04 0x00 0x34 0x11 0x03 0x00 0x60
			Status		Read		0x07 0x14 0x00 0x05 0x00 0x34 0x00 0x00 0x11 0x03 0x61
		Gamma	Film				0x06 0x14 0x00 0x04 0x00 0x34 0x11 0x05 0x00 0x62
						Film Curve -	0x06 0x14 0x00 0x04 0x00 0x34 0x12 0x45 0x00 0xA3
						Film Curve +	0x06 0x14 0x00 0x04 0x00 0x34 0x12 0x45 0x01 0xA4
						Film Curve Type Read	0x07 0x14 0x00 0x05 0x00 0x34 0x00 0x00 0x12 0x45 0xA4
			Video				0x06 0x14 0x00 0x04 0x00 0x34 0x11 0x05 0x04 0x66
		Graphics				0x06 0x14 0x00 0x04 0x00 0x34 0x11 0x05 0x0A 0x6C	
		Standard				0x06 0x14 0x00 0x04 0x00 0x34 0x11 0x05 0x02 0x64	
		DynamicBlack	On / Off			On	0x06 0x14 0x00 0x04 0x00 0x34 0x12 0x0F 0x01 0x6E
						Off	0x06 0x14 0x00 0x04 0x00 0x34 0x12 0x0F 0x00 0x6D
					Read	0x07 0x14 0x00 0x05 0x00 0x34 0x00 0x00 0x12 0x0F 0x6E	
	Color Temp.	Warm				0x06 0x14 0x00 0x04 0x00 0x34 0x12 0x08 0x00 0x66	
		Medium				0x06 0x14 0x00 0x04 0x00 0x34 0x12 0x08 0x01 0x67	
		Cool				0x06 0x14 0x00 0x04 0x00 0x34 0x12 0x08 0x02 0x68	
					Read	0x07 0x14 0x00 0x05 0x00 0x34 0x00 0x00 0x12 0x08 0x67	
	Color Space (either one)	Auto			other source	0x06 0x14 0x00 0x04 0x00 0x34 0x12 0x18 0x00 0x76	
		RGB				0x06 0x14 0x00 0x04 0x00 0x34 0x12 0x18 0x01 0x77	
		YUV				0x06 0x14 0x00 0x04 0x00 0x34 0x12 0x18 0x03 0x79	
					Read	0x07 0x14 0x00 0x05 0x00 0x34 0x00 0x00 0x12 0x18 0x77	
	Color Space (either one)	Auto				0x06 0x14 0x00 0x04 0x00 0x34 0x12 0x18 0x00 0x76	
		RGB (0-255)				0x06 0x14 0x00 0x04 0x00 0x34 0x12 0x18 0x01 0x77	
		RGB (16-235)				0x06 0x14 0x00 0x04 0x00 0x34 0x12 0x18 0x02 0x78	
					Read	0x06 0x14 0x00 0x04 0x00 0x34 0x12 0x18 0x03 0x79	
					Read	0x07 0x14 0x00 0x05 0x00 0x34 0x00 0x00 0x12 0x18 0x77	
	Color Settings	Red Gain				-	0x06 0x14 0x00 0x04 0x00 0x34 0x12 0x1A 0x00 0x78
						+	0x06 0x14 0x00 0x04 0x00 0x34 0x12 0x1A 0x01 0x79
			Read				0x07 0x14 0x00 0x05 0x00 0x34 0x00 0x00 0x12 0x1A 0x79
		Green Gain				-	0x06 0x14 0x00 0x04 0x00 0x34 0x12 0x1B 0x00 0x79
						+	0x06 0x14 0x00 0x04 0x00 0x34 0x12 0x1B 0x01 0x7A
			Read				0x07 0x14 0x00 0x05 0x00 0x34 0x00 0x00 0x12 0x1B 0x7A
	Blue Gain				-	0x06 0x14 0x00 0x04 0x00 0x34 0x12 0x1C 0x00 0x7A	
					+	0x06 0x14 0x00 0x04 0x00 0x34 0x12 0x1C 0x01 0x7B	
		Read				0x07 0x14 0x00 0x05 0x00 0x34 0x00 0x00 0x12 0x1C 0x7B	

Main Menu	Sub Menu	Sub Menu 2	Sub Menu 3	Sub Menu 4	Value	RS232 Command		
PICTURE	Advanced	Color Settings	Red Bias		-	0x06 0x14 0x00 0x04 0x00 0x34 0x12 0x1D 0x00 0x7B		
				Read	+	0x06 0x14 0x00 0x04 0x00 0x34 0x12 0x1D 0x01 0x7C		
			Green Bias		-	0x06 0x14 0x00 0x04 0x00 0x34 0x12 0x1E 0x00 0x7C		
				Read	+	0x06 0x14 0x00 0x04 0x00 0x34 0x12 0x1E 0x01 0x7D		
			Blue Bias		-	0x06 0x14 0x00 0x04 0x00 0x34 0x12 0x1F 0x00 0x7D		
				Read	+	0x06 0x14 0x00 0x04 0x00 0x34 0x12 0x1F 0x01 0x7E		
		Input Source	Reset				0x06 0x14 0x00 0x04 0x00 0x34 0x12 0x20 0x00 0x7E	
			Exit				0x02 0x14 0x00 0x04 0x00 0x34 0x02 0x04 0x0A 0x5C	
			HDMI				0x06 0x14 0x00 0x04 0x00 0x34 0x13 0x01 0x03 0x63	
			DVI				0x06 0x14 0x00 0x04 0x00 0x34 0x13 0x01 0x04 0x64	
			VGA				0x06 0x14 0x00 0x04 0x00 0x34 0x13 0x01 0x00 0x60	
			BNC				0x06 0x14 0x00 0x04 0x00 0x34 0x13 0x01 0x08 0x68	
			S-Video				0x06 0x14 0x00 0x04 0x00 0x34 0x13 0x01 0x06 0x66	
			Video (CVBS)				0x06 0x14 0x00 0x04 0x00 0x34 0x13 0x01 0x05 0x65	
				Read			0x07 0x14 0x00 0x05 0x00 0x34 0x00 0x00 0x13 0x01 0x61	
			Exit				0x02 0x14 0x00 0x04 0x00 0x34 0x02 0x04 0x0A 0x5C	
		Exit				0x02 0x14 0x00 0x04 0x00 0x34 0x02 0x04 0x0A 0x5C		
		SCREEN	Aspect	4:3				0x06 0x14 0x00 0x04 0x00 0x34 0x12 0x04 0x02 0x64
				16 : 9				0x06 0x14 0x00 0x04 0x00 0x34 0x12 0x04 0x03 0x65
				Native				0x06 0x14 0x00 0x04 0x00 0x34 0x12 0x04 0x01 0x63
				Auto				0x06 0x14 0x00 0x04 0x00 0x34 0x12 0x04 0x00 0x62
			Zoom				+	0x06 0x14 0x00 0x04 0x00 0x34 0x12 0x19 0x01 0x78
				Read			-	0x06 0x14 0x00 0x04 0x00 0x34 0x12 0x19 0x00 0x77
			Overscan				0%	0x06 0x14 0x00 0x04 0x00 0x34 0x11 0x09 0x00 0x66
					2%	0x06 0x14 0x00 0x04 0x00 0x34 0x11 0x09 0x01 0x67		
					4%	0x06 0x14 0x00 0x04 0x00 0x34 0x11 0x09 0x02 0x68		
					6%	0x06 0x14 0x00 0x04 0x00 0x34 0x11 0x09 0x03 0x69		
					8%	0x06 0x14 0x00 0x04 0x00 0x34 0x11 0x09 0x04 0x6A		
					10%	0x06 0x14 0x00 0x04 0x00 0x34 0x11 0x09 0x05 0x6B		
H Image Shift +	Write					0x06 0x14 0x00 0x04 0x00 0x34 0x11 0x08 0x21 0x86		
H Image Shift -	Write					0x06 0x14 0x00 0x04 0x00 0x34 0x11 0x08 0x20 0x85		
H Image	Read					0x07 0x14 0x00 0x05 0x00 0x34 0x00 0x00 0x13 0x08 0x68		
H Image								
V Image Shift +	Write					0x06 0x14 0x00 0x04 0x00 0x34 0x11 0x07 0x21 0x85		
V Image Shift -	Write					0x06 0x14 0x00 0x04 0x00 0x34 0x11 0x07 0x20 0x84		
V Image	Read					0x07 0x14 0x00 0x05 0x00 0x34 0x00 0x00 0x13 0x07 0x67		
V Image								
Geometry	PC Mode		ON Write				0x06 0x14 0x00 0x04 0x00 0x34 0x11 0x31 0x01 0x8F	
			OFF Write				0x06 0x14 0x00 0x04 0x00 0x34 0x11 0x31 0x00 0x8E	
			PC Mode status Read				0x07 0x14 0x00 0x05 0x00 0x34 0x00 0x00 0x13 0x31 0x91	
	Warp		ON (Write)				0x06 0x14 0x00 0x04 0x00 0x34 0x11 0x30 0x01 0x8E	
		Off (Write)				0x06 0x14 0x00 0x04 0x00 0x34 0x11 0x30 0x00 0x8D		
		Read				0x07 0x14 0x00 0x05 0x00 0x34 0x00 0x00 0x13 0x30 0x90		
	Keystone	Keystone H +			+	0x06 0x14 0x00 0x04 0x00 0x34 0x11 0x05 0x01 0x63		
		Keystone H -			-	0x06 0x14 0x00 0x04 0x00 0x34 0x11 0x05 0x00 0x62		
		Keystone H Status			Read	0x07 0x14 0x00 0x05 0x00 0x34 0x00 0x00 0x13 0x05 0x65		
		Keystone V +			+	0x06 0x14 0x00 0x04 0x00 0x34 0x11 0x06 0x01 0x64		
		Keystone V -			-	0x06 0x14 0x00 0x04 0x00 0x34 0x11 0x06 0x00 0x63		
		Keystone V Status			Read	0x07 0x14 0x00 0x05 0x00 0x34 0x00 0x00 0x13 0x06 0x66		
		Pin Cushion/Barrel Status			Read	0x07 0x14 0x00 0x05 0x00 0x34 0x00 0x00 0x13 0x04 0x64		
	Reset					0x06 0x14 0x00 0x04 0x00 0x34 0x13 0x03 0x00 0x62		
	4-Corner	Top Left +					0x06 0x14 0x00 0x04 0x00 0x34 0x11 0xA0 0x01 0xFE	
		Top Left -					0x06 0x14 0x00 0x04 0x00 0x34 0x11 0xA0 0x00 0xFD	
		Top Left Read					0x07 0x14 0x00 0x05 0x00 0x34 0x00 0x00 0x13 0xA0 0x00	
		Top Right +					0x06 0x14 0x00 0x04 0x00 0x34 0x11 0xA1 0x01 0xFF	
		Top Right -					0x06 0x14 0x00 0x04 0x00 0x34 0x11 0xA1 0x00 0xFE	
		Top Right Read					0x07 0x14 0x00 0x05 0x00 0x34 0x00 0x00 0x13 0xA1 0x01	
Bottom Left +						0x06 0x14 0x00 0x04 0x00 0x34 0x11 0xA2 0x01 0x00		
Bottom Left -						0x06 0x14 0x00 0x04 0x00 0x34 0x11 0xA2 0x00 0xFF		

Main Menu	Sub Menu	Sub Menu 2	Sub Menu 3	Sub Menu 4	Value	RS232 Command			
SCREEN	Geometry	4-Corner	Bottom Left Read			0x07 0x14 0x00 0x05 0x00 0x34 0x00 0x00 0x13 0xA2 0x02			
			Bottom Right +			0x06 0x14 0x00 0x04 0x00 0x34 0x11 0xA3 0x01 0x01			
			Bottom Right -			0x06 0x14 0x00 0x04 0x00 0x34 0x11 0xA3 0x00 0x00			
			Bottom Right Read			0x07 0x14 0x00 0x05 0x00 0x34 0x00 0x00 0x13 0xA3 0x03			
			Digital Shift +			0x06 0x14 0x00 0x04 0x00 0x34 0x11 0xA4 0x01 0x02			
			Digital Shift -			0x06 0x14 0x00 0x04 0x00 0x34 0x11 0xA4 0x00 0x01			
			Digital Shift Read			0x07 0x14 0x00 0x05 0x00 0x34 0x00 0x00 0x13 0xA4 0x04			
		Reset				0x06 0x14 0x00 0x04 0x00 0x34 0x13 0x9F 0x00 0xFE			
		Point 1 +				0x06 0x14 0x00 0x04 0x00 0x34 0x11 0xA5 0x01 0x03			
		Point 1 -				0x06 0x14 0x00 0x04 0x00 0x34 0x11 0xA5 0x00 0x02			
		Point 1 (Read)				0x07 0x14 0x00 0x05 0x00 0x34 0x00 0x00 0x13 0xA5 0x05			
		Point 2 +				0x06 0x14 0x00 0x04 0x00 0x34 0x11 0xA6 0x01 0x04			
		Point 2 -				0x06 0x14 0x00 0x04 0x00 0x34 0x11 0xA6 0x00 0x03			
		Point 2 (Read)				0x07 0x14 0x00 0x05 0x00 0x34 0x00 0x00 0x13 0xA6 0x06			
		Point 3 +				0x06 0x14 0x00 0x04 0x00 0x34 0x11 0xA7 0x01 0x05			
		Point 3 -				0x06 0x14 0x00 0x04 0x00 0x34 0x11 0xA7 0x00 0x04			
		Point 3 (Read)				0x07 0x14 0x00 0x05 0x00 0x34 0x00 0x00 0x13 0xA7 0x07			
		Point 4 +				0x06 0x14 0x00 0x04 0x00 0x34 0x11 0xA8 0x01 0x06			
		Point 4 -				0x06 0x14 0x00 0x04 0x00 0x34 0x11 0xA8 0x00 0x05			
		Point 4 (Read)				0x07 0x14 0x00 0x05 0x00 0x34 0x00 0x00 0x13 0xA8 0x08			
		Point 5 +				0x06 0x14 0x00 0x04 0x00 0x34 0x11 0xA9 0x01 0x07			
		Point 5 -				0x06 0x14 0x00 0x04 0x00 0x34 0x11 0xA9 0x00 0x06			
		Point 5 (Read)				0x07 0x14 0x00 0x05 0x00 0x34 0x00 0x00 0x13 0xA9 0x09			
		Point 6 +				0x06 0x14 0x00 0x04 0x00 0x34 0x11 0xAA 0x01 0x08			
		Point 6 -				0x06 0x14 0x00 0x04 0x00 0x34 0x11 0xAA 0x00 0x07			
		Point 6(Read)				0x07 0x14 0x00 0x05 0x00 0x34 0x00 0x00 0x13 0xAA 0x0A			
		Point 7 +				0x06 0x14 0x00 0x04 0x00 0x34 0x11 0xAB 0x01 0x09			
		Point 7 -				0x06 0x14 0x00 0x04 0x00 0x34 0x11 0xAB 0x00 0x08			
		Point 7 (Read)				0x07 0x14 0x00 0x05 0x00 0x34 0x00 0x00 0x13 0xAB 0x0B			
		Point 8 +				0x06 0x14 0x00 0x04 0x00 0x34 0x11 0xAC 0x01 0x0A			
		Point 8 -				0x06 0x14 0x00 0x04 0x00 0x34 0x11 0xAC 0x00 0x09			
		Point 8 (Read)				0x07 0x14 0x00 0x05 0x00 0x34 0x00 0x00 0x13 0xAC 0x0C			
		Point 9 +				0x06 0x14 0x00 0x04 0x00 0x34 0x11 0xAD 0x01 0x0B			
		Point 9 -				0x06 0x14 0x00 0x04 0x00 0x34 0x11 0xAD 0x00 0x0A			
		Point 9 (Read)				0x07 0x14 0x00 0x05 0x00 0x34 0x00 0x00 0x13 0xAD 0x0D			
		Reset				0x06 0x14 0x00 0x04 0x00 0x34 0x13 0xAE 0x00 0x0D			
		Rotation	Rotation Status			Read	0x07 0x14 0x00 0x05 0x00 0x34 0x00 0x00 0x13 0x90 0xF0		
			Pin Cushion/Barrel Status			Read	0x07 0x14 0x00 0x05 0x00 0x34 0x00 0x00 0x13 0x91 0xF1		
			Reset				0x06 0x14 0x00 0x04 0x00 0x34 0x13 0x92 0x00 0xF1		
		V Keystone				+	0x06 0x14 0x00 0x04 0x00 0x34 0x12 0x0A 0x00 0x88		
						-	0x06 0x14 0x00 0x04 0x00 0x34 0x12 0x0A 0x01 0x89		
			Read				0x07 0x14 0x00 0x05 0x00 0x34 0x00 0x00 0x12 0x0A 0x89		
		PIP / POP	Screen				PIP Off	0x06 0x14 0x00 0x04 0x00 0x34 0x13 0x46 0x00 0xA5	
							PIP	0x06 0x14 0x00 0x04 0x00 0x34 0x13 0x46 0x01 0xA6	
							POP	0x06 0x14 0x00 0x04 0x00 0x34 0x13 0x46 0x02 0xA7	
					Read			0x07 0x14 0x00 0x05 0x00 0x34 0x00 0x00 0x12 0x46 0xA5	
			PIP Location					PIP Location RT	0x06 0x14 0x00 0x04 0x00 0x34 0x13 0x47 0x00 0xA6
								PIP Location LT	0x06 0x14 0x00 0x04 0x00 0x34 0x13 0x47 0x01 0xA7
								PIP Location LB	0x06 0x14 0x00 0x04 0x00 0x34 0x13 0x47 0x02 0xA8
								PIP Location RB	0x06 0x14 0x00 0x04 0x00 0x34 0x13 0x47 0x03 0xA9
					Read				0x07 0x14 0x00 0x05 0x00 0x34 0x00 0x00 0x12 0x47 0xA6
			PIP Size	1/16, 1/25, 1/36				PIP Size 1/16	0x06 0x14 0x00 0x04 0x00 0x34 0x13 0x48 0x00 0xA7
						PIP Size 1/25	0x06 0x14 0x00 0x04 0x00 0x34 0x13 0x48 0x01 0xA8		
						PIP Size 1/36	0x06 0x14 0x00 0x04 0x00 0x34 0x13 0x48 0x02 0xA9		
Read							0x07 0x14 0x00 0x05 0x00 0x34 0x00 0x00 0x12 0x48 0xA7		
PIP / POP Source	*HDMI / VGA or BNC / S-Video / CVBS / DVI					HDMI	0x06 0x14 0x00 0x04 0x00 0x34 0x13 0x49 0x03 0xAB		
						DVI	0x06 0x14 0x00 0x04 0x00 0x34 0x13 0x49 0x04 0xAC		
						VGA	0x06 0x14 0x00 0x04 0x00 0x34 0x13 0x49 0x05 0xAD		
						BNC	0x06 0x14 0x00 0x04 0x00 0x34 0x13 0x49 0x06 0xAE		
					S-Video	0x06 0x14 0x00 0x04 0x00 0x34 0x13 0x49 0x07 0xAF			
					CVBS	0x06 0x14 0x00 0x04 0x00 0x34 0x13 0x49 0x08 0xB0			
		Read				0x07 0x14 0x00 0x05 0x00 0x34 0x00 0x00 0x12 0x49 0xA8			
Swap					0x06 0x14 0x00 0x04 0x00 0x34 0x02 0x04 0x0A 0x5C				
Exit					0x02 0x14 0x00 0x04 0x00 0x34 0x02 0x04 0x0A 0x5C				

Main Menu	Sub Menu	Sub Menu 2	Sub Menu 3	Sub Menu 4	Value	RS232 Command		
SETTING	Language	English				0x06 0x14 0x00 0x04 0x00 0x34 0x15 0x00 0x00 0x61		
		German				0x06 0x14 0x00 0x04 0x00 0x34 0x15 0x00 0x02 0x63		
		French				0x06 0x14 0x00 0x04 0x00 0x34 0x15 0x00 0x01 0x62		
		Spanish				0x06 0x14 0x00 0x04 0x00 0x34 0x15 0x00 0x04 0x65		
		Italian				0x06 0x14 0x00 0x04 0x00 0x34 0x15 0x00 0x03 0x64		
		Russian				0x06 0x14 0x00 0x04 0x00 0x34 0x15 0x00 0x05 0x66		
		Portuguese				0x06 0x14 0x00 0x04 0x00 0x34 0x15 0x00 0x06 0x6F		
		Swedish				0x06 0x14 0x00 0x04 0x00 0x34 0x15 0x00 0x0a 0x6B		
		Simplified Chinese				0x06 0x14 0x00 0x04 0x00 0x34 0x15 0x00 0x07 0x68		
		Korean				0x06 0x14 0x00 0x04 0x00 0x34 0x15 0x00 0x09 0x6A		
		Traditional Chinese				0x06 0x14 0x00 0x04 0x00 0x34 0x15 0x00 0x06 0x67		
		Turkish				0x06 0x14 0x00 0x04 0x00 0x34 0x15 0x00 0x0c 0x6D		
		Polish				0x06 0x14 0x00 0x04 0x00 0x34 0x15 0x00 0x10 0x71		
		Japanese				0x06 0x14 0x00 0x04 0x00 0x34 0x15 0x00 0x08 0x69		
	Norwegian				0x06 0x14 0x00 0x04 0x00 0x34 0x15 0x00 0x15 0x76			
	Exit					0x02 0x14 0x00 0x04 0x00 0x34 0x02 0x04 0x0A 0x5C		
	Projection	Front-Desktop					0x06 0x14 0x00 0x04 0x00 0x34 0x12 0x00 0x00 0x5E	
		Rear-Desktop					0x06 0x14 0x00 0x04 0x00 0x34 0x12 0x00 0x01 0x5F	
		Front-Ceiling					0x06 0x14 0x00 0x04 0x00 0x34 0x12 0x00 0x03 0x61	
		Rear-Ceiling					0x06 0x14 0x00 0x04 0x00 0x34 0x12 0x00 0x02 0x60	
			Read				0x07 0x14 0x00 0x05 0x00 0x34 0x00 0x00 0x12 0x00 0x5F	
	Menu Location	Top Left					0x06 0x14 0x00 0x04 0x00 0x34 0x20 0x00 0x01 0x6D	
		Top Right					0x06 0x14 0x00 0x04 0x00 0x34 0x20 0x00 0x02 0x6E	
		Center					0x06 0x14 0x00 0x04 0x00 0x34 0x20 0x00 0x00 0x6C	
		Bottom Left					0x06 0x14 0x00 0x04 0x00 0x34 0x20 0x00 0x04 0x70	
		Bottom Right					0x06 0x14 0x00 0x04 0x00 0x34 0x20 0x00 0x03 0x6F	
			Read				0x07 0x14 0x00 0x05 0x00 0x34 0x00 0x00 0x20 0x00 0x6D	
	Lens Function	Zoom	Lock		Lock		0x06 0x14 0x00 0x04 0x00 0x34 0x12 0x54 0x00 0x62	
					Unlock		0x06 0x14 0x00 0x04 0x00 0x34 0x12 0x54 0x01 0x63	
					Read			0x07 0x14 0x00 0x05 0x00 0x34 0x00 0x00 0x12 0x59 0xB8
						Zoom+		0x06 0x14 0x00 0x04 0x00 0x34 0x12 0x59 0x01 0xB8
						Zoom-		0x06 0x14 0x00 0x04 0x00 0x34 0x12 0x59 0x00 0xB7
		Focus	Lock		Lock		0x06 0x14 0x00 0x04 0x00 0x34 0x12 0x55 0x00 0xB3	
					Unlock		0x06 0x14 0x00 0x04 0x00 0x34 0x12 0x55 0x01 0xB4	
					Read			0x07 0x14 0x00 0x05 0x00 0x34 0x00 0x00 0x12 0x5A 0xB9
						Focus+		0x06 0x14 0x00 0x04 0x00 0x34 0x12 0x5A 0x01 0xB9
						Focus-		0x06 0x14 0x00 0x04 0x00 0x34 0x12 0x5A 0x00 0xB8
		Lens Shift	Lock / Unlock		Lock		0x06 0x14 0x00 0x04 0x00 0x34 0x12 0x5B 0x00 0xB9	
					Unlock		0x06 0x14 0x00 0x04 0x00 0x34 0x12 0x5B 0x01 0xBA	
						UP		0x06 0x14 0x00 0x04 0x00 0x34 0x12 0x5C 0x00 0xBA
					Down		0x06 0x14 0x00 0x04 0x00 0x34 0x12 0x5C 0x01 0xBB	
					Left		0x06 0x14 0x00 0x04 0x00 0x34 0x12 0x5C 0x02 0xBC	
					Right		0x06 0x14 0x00 0x04 0x00 0x34 0x12 0x5C 0x03 0xBD	
			Read				0x07 0x14 0x00 0x05 0x00 0x34 0x00 0x00 0x12 0x5B 0xBA	
		Lens Position	1 / 2 / 3		Select / Save	1 (Command: Select)		0x06 0x14 0x00 0x04 0x00 0x34 0x12 0x5D 0x00 0xBB
					2 (Command: Select)		0x06 0x14 0x00 0x04 0x00 0x34 0x12 0x5D 0x01 0xBC	
					3 (Command: Select)		0x06 0x14 0x00 0x04 0x00 0x34 0x12 0x5D 0x02 0xBD	
			Read			0x07 0x14 0x00 0x05 0x00 0x34 0x00 0x00 0x12 0x5D 0xBC		
	Lens Calibration	No					0x06 0x14 0x00 0x04 0x00 0x34 0x12 0x5F 0x00 0xBD	
		Yes					0x06 0x14 0x00 0x04 0x00 0x34 0x12 0x5F 0x01 0xBE	
Exit						0x02 0x14 0x00 0x04 0x00 0x34 0x02 0x04 0x0A 0x5C		
Security	Security Timer	Month						
				Read			0x07 0x14 0x00 0x05 0x00 0x34 0x00 0x00 0x12 0x66 0xC5	
		Day						
				Read				0x07 0x14 0x00 0x05 0x00 0x34 0x00 0x00 0x12 0x67 0xC6
		Hour						
			Read				0x07 0x14 0x00 0x05 0x00 0x34 0x00 0x00 0x12 0x68 0xC7	
Security	On / Off			Off		0x02 0x14 0x00 0x04 0x00 0x34 0x02 0x04 0x0A 0x5C		
				On		0x06 0x14 0x00 0x04 0x00 0x34 0x12 0x62 0x01 0xC1		
			Read			0x07 0x14 0x00 0x05 0x00 0x34 0x00 0x00 0x12 0x62 0xC1		
Exit						0x02 0x14 0x00 0x04 0x00 0x34 0x02 0x04 0x0A 0x5C		
Signal (RGB)	Frequency			Frequency -		0x06 0x14 0x00 0x04 0x00 0x34 0x12 0x15 0x00 0x73		
				Frequency +		0x06 0x14 0x00 0x04 0x00 0x34 0x12 0x15 0x01 0x74		
			Read				0x07 0x14 0x00 0x05 0x00 0x34 0x00 0x00 0x12 0x15 0x74	

Main Menu	Sub Menu	Sub Menu 2	Sub Menu 3	Sub Menu 4	Value	RS232 Command	
SETTING	Signal (RGB)	Phase			Phase -	0x06 0x14 0x00 0x04 0x00 0x34 0x12 0x14 0x00 0x72	
					Phase +	0x06 0x14 0x00 0x04 0x00 0x34 0x12 0x14 0x01 0x73	
			Read			0x07 0x14 0x00 0x05 0x00 0x34 0x00 0x00 0x12 0x14 0x73	
		H. Position				Horizontal position shift right	0x06 0x14 0x00 0x04 0x00 0x34 0x12 0x06 0x01 0x65
						Horizontal position shift left	0x06 0x14 0x00 0x04 0x00 0x34 0x12 0x06 0x00 0x64
			Read				0x07 0x14 0x00 0x05 0x00 0x34 0x00 0x00 0x12 0x06 0x65
		V. Position				Vertical position shift up	0x06 0x14 0x00 0x04 0x00 0x34 0x12 0x07 0x00 0x65
						Vertical position shift down	0x06 0x14 0x00 0x04 0x00 0x34 0x12 0x07 0x01 0x66
			Read				0x07 0x14 0x00 0x05 0x00 0x34 0x00 0x00 0x12 0x07 0x66
		Automatic	Enable / Disable			Automatic En	0x06 0x14 0x00 0x04 0x00 0x34 0x12 0x17 0x00 0x75
						Automatic Disable	0x06 0x14 0x00 0x04 0x00 0x34 0x12 0x17 0x01 0x76
			Read				0x07 0x14 0x00 0x05 0x00 0x34 0x00 0x00 0x12 0x17 0x76
		Exit					0x02 0x14 0x00 0x04 0x00 0x34 0x02 0x04 0x0A 0x5C
		Signal (Video)	White Level			-	0x06 0x14 0x00 0x04 0x00 0x34 0x12 0x30 0x00 0x5E
					+	0x06 0x14 0x00 0x04 0x00 0x34 0x12 0x30 0x01 0x5F	
	Read						0x07 0x14 0x00 0x05 0x00 0x34 0x00 0x00 0x12 0x30 0x66
	Black Level				-	0x06 0x14 0x00 0x04 0x00 0x34 0x12 0x31 0x00 0x8F	
					+	0x06 0x14 0x00 0x04 0x00 0x34 0x12 0x31 0x01 0x90	
			Read				0x07 0x14 0x00 0x05 0x00 0x34 0x00 0x00 0x12 0x31 0x90
	Saturation				-	0x06 0x14 0x00 0x04 0x00 0x34 0x12 0x32 0x00 0x90	
					+	0x06 0x14 0x00 0x04 0x00 0x34 0x12 0x32 0x01 0x91	
			Read				0x07 0x14 0x00 0x05 0x00 0x34 0x00 0x00 0x12 0x32 0x91
					-	0x06 0x14 0x00 0x04 0x00 0x34 0x12 0x33 0x00 0x91	
					+	0x06 0x14 0x00 0x04 0x00 0x34 0x12 0x33 0x01 0x91	
	Read					0x07 0x14 0x00 0x05 0x00 0x34 0x00 0x00 0x12 0x33 0x92	
	IRE				0	0x06 0x14 0x00 0x04 0x00 0x34 0x13 0x34 0x00 0x93	
					7.5	0x06 0x14 0x00 0x04 0x00 0x34 0x13 0x34 0x01 0x94	
		Read				0x07 0x14 0x00 0x05 0x00 0x34 0x00 0x00 0x12 0x34 0x93	
	Exit					0x02 0x14 0x00 0x04 0x00 0x34 0x02 0x04 0x0A 0x5C	
	Projector No				Projector ID +	0x06 0x14 0x00 0x04 0x00 0x34 0x12 0x38 0x00 0x96	
					Projector ID -	0x06 0x14 0x00 0x04 0x00 0x34 0x12 0x38 0x01 0x97	
		Read				0x07 0x14 0x00 0x05 0x00 0x34 0x00 0x00 0x12 0x38 0x97	
	Audio Settings	Internal Speaker	On / Off		Speaker ON	0x06 0x14 0x00 0x04 0x00 0x34 0x14 0x03 0x01 0x64	
					Speaker OFF	0x06 0x14 0x00 0x04 0x00 0x34 0x14 0x03 0x00 0x63	
			Read			0x07 0x14 0x00 0x05 0x00 0x34 0x00 0x00 0x14 0x03 0x64	
		Mute	On / Off		Mute on	0x06 0x14 0x00 0x04 0x00 0x34 0x14 0x00 0x01 0x61	
					Mute off (De-Mute/ Vol +/-)	0x06 0x14 0x00 0x04 0x00 0x34 0x14 0x00 0x00 0x60	
			Read			0x07 0x14 0x00 0x05 0x00 0x34 0x00 0x00 0x14 0x00 0x61	
		Volume	+		Increase Volume	0x06 0x14 0x00 0x04 0x00 0x34 0x14 0x01 0x00 0x61	
					Decrease Volume	0x06 0x14 0x00 0x04 0x00 0x34 0x14 0x02 0x00 0x62	
			Read			0x07 0x14 0x00 0x05 0x00 0x34 0x00 0x00 0x14 0x04 0x65	
		Exit					0x02 0x14 0x00 0x04 0x00 0x34 0x02 0x04 0x0A 0x5C
	Advanced	Logo	Viewsonic / Neutral / User		Viewsonic	0x06 0x14 0x00 0x04 0x00 0x34 0x11 0x0B 0x02 0x6A	
					Neutral	0x06 0x14 0x00 0x04 0x00 0x34 0x11 0x0B 0x05 0x6D	
					User	0x06 0x14 0x00 0x04 0x00 0x34 0x11 0x0B 0x03 0x6B	
		Logo Capture	On / Off			0x06 0x14 0x00 0x04 0x00 0x34 0x11 0x0A 0xFF 0x66	
		Closed Captioning	CC1 / CC2 / CC3 / CC4 / Off		Off	0x06 0x14 0x00 0x04 0x00 0x34 0x12 0x21 0x00 0x7F	
					CC1	0x06 0x14 0x00 0x04 0x00 0x34 0x12 0x21 0x01 0x80	
					CC2	0x06 0x14 0x00 0x04 0x00 0x34 0x12 0x21 0x02 0x81	
					CC3	0x06 0x14 0x00 0x04 0x00 0x34 0x12 0x21 0x03 0x82	
					CC4	0x06 0x14 0x00 0x04 0x00 0x34 0x12 0x21 0x04 0x83	
		Read				0x07 0x14 0x00 0x05 0x00 0x34 0x00 0x00 0x12 0x21 0x80	
		Exit					0x02 0x14 0x00 0x04 0x00 0x34 0x02 0x04 0x0A 0x5C

Main Menu	Sub Menu	Sub Menu 2	Sub Menu 3	Sub Menu 4	Value	RS232 Command	
SETTING	Auto Source		On / Off		Quick Auto Search on	0x06 0x14 0x00 0x04 0x00 0x34 0x13 0x02 0x01 0x62	
					Quick Auto Search off	0x06 0x14 0x00 0x04 0x00 0x34 0x13 0x02 0x00 0x61	
				Read			0x07 0x14 0x00 0x05 0x00 0x34 0x00 0x00 0x13 0x02 0x62
	High Altitude		On / Off			Off	0x06 0x14 0x00 0x04 0x00 0x34 0x11 0x0C 0x00 0x69
						On	0x06 0x14 0x00 0x04 0x00 0x34 0x11 0x0C 0x01 0x6A
				Read			0x07 0x14 0x00 0x05 0x00 0x34 0x00 0x00 0x11 0x0C 0x6A
	Status Hide		Off			Off	0x06 0x14 0x00 0x04 0x00 0x34 0x11 0x27 0x00 0x84
			On			On	0x06 0x14 0x00 0x04 0x00 0x34 0x11 0x27 0x01 0x85
				Read			0x07 0x14 0x00 0x05 0x00 0x34 0x00 0x00 0x11 0x27 0x85
	Keypad Lock		Lock / Unlock			Lock	0x06 0x14 0x00 0x04 0x00 0x34 0x12 0x58 0x00 0x86
						Unlock	0x06 0x14 0x00 0x04 0x00 0x34 0x12 0x58 0x01 0x87
				Read			0x07 0x14 0x00 0x05 0x00 0x34 0x00 0x00 0x12 0x58 0x87
	Test Pattern	None					0x06 0x14 0x00 0x04 0x00 0x34 0x11 0xB2 0x00 0x0F
		Grid					0x06 0x14 0x00 0x04 0x00 0x34 0x11 0xB2 0x01 0x10
		White					0x06 0x14 0x00 0x04 0x00 0x34 0x11 0xB2 0x02 0x11
	Background Color		Blue / Black / Red / Green / White			Blue	0x06 0x14 0x00 0x04 0x00 0x34 0x11 0x0A 0x01 0x68
						Black	0x06 0x14 0x00 0x04 0x00 0x34 0x11 0x0A 0x00 0x67
						Red	0x06 0x14 0x00 0x04 0x00 0x34 0x11 0x0A 0x04 0x6B
						Green	0x06 0x14 0x00 0x04 0x00 0x34 0x11 0x0A 0x05 0x6C
						White	0x06 0x14 0x00 0x04 0x00 0x34 0x11 0x0A 0x06 0x6D
Lamp Settings	Lamp Hour		Read			0x07 0x14 0x00 0x05 0x00 0x34 0x00 0x00 0x15 0x01 0x63	
	Lamp Reminder		On / Off			Off	0x06 0x14 0x00 0x04 0x00 0x34 0x15 0x02 0x00 0x63
						On	0x06 0x14 0x00 0x04 0x00 0x34 0x15 0x02 0x01 0x64
				Read			0x07 0x14 0x00 0x05 0x00 0x34 0x00 0x00 0x15 0x02 0x64
	Lamp Mode		Normal				0x06 0x14 0x00 0x04 0x00 0x34 0x11 0x10 0x00 0x6D
			ECCO				0x06 0x14 0x00 0x04 0x00 0x34 0x11 0x10 0x01 0x6E
			Power				0x06 0x14 0x00 0x04 0x00 0x34 0x11 0x10 0x02 0x6F
				Read Lamp Mode status			0x07 0x14 0x00 0x05 0x00 0x34 0x00 0x00 0x11 0x10 0x6E
				Read Power value			0x07 0x14 0x00 0x05 0x00 0x34 0x00 0x00 0x12 0x2A 0x89
	Lamp Reset	Yes/No				0x06 0x14 0x00 0x04 0x00 0x34 0x15 0x10 0x00 0x62	
	Exit					0x02 0x14 0x00 0x04 0x00 0x34 0x02 0x04 0x0A 0x5C	
	Remote Settings	Top IR Function		On / Off		Top IR OFF	0x06 0x14 0x00 0x04 0x00 0x34 0x13 0x51 0x00 0x80
						Top IR ON	0x06 0x14 0x00 0x04 0x00 0x34 0x13 0x51 0x01 0x81
				Read			0x07 0x14 0x00 0x05 0x00 0x34 0x00 0x00 0x12 0x51 0x80
		Front IR Function		On / Off		Front IR OFF	0x06 0x14 0x00 0x04 0x00 0x34 0x13 0x52 0x00 0x81
					Front IR ON	0x06 0x14 0x00 0x04 0x00 0x34 0x13 0x52 0x01 0x82	
				Read			0x07 0x14 0x00 0x05 0x00 0x34 0x00 0x00 0x12 0x52 0x81
Remote Code					-	0x06 0x14 0x00 0x04 0x00 0x34 0x12 0x50 0x00 0xAE	
				+	0x06 0x14 0x00 0x04 0x00 0x34 0x12 0x50 0x01 0xAF		
Exit	Read				0x07 0x14 0x00 0x05 0x00 0x34 0x00 0x00 0x12 0x50 0xAF		
12V Trigger		On / Off			12V OFF	0x06 0x14 0x00 0x04 0x00 0x34 0x13 0x53 0x00 0xB2	
					12V ON	0x06 0x14 0x00 0x04 0x00 0x34 0x13 0x53 0x01 0xB3	
		Read				0x07 0x14 0x00 0x05 0x00 0x34 0x00 0x00 0x12 0x53 0xB2	
Advanced	Direct Power On		On / Off		Off	0x06 0x14 0x00 0x04 0x00 0x34 0x13 0x54 0x00 0xB3	
					On	0x06 0x14 0x00 0x04 0x00 0x34 0x13 0x54 0x01 0xB4	
				Read			0x07 0x14 0x00 0x05 0x00 0x34 0x00 0x00 0x12 0x54 0xB3
	Auto Power Off				-	0x06 0x14 0x00 0x04 0x00 0x34 0x12 0x56 0x00 0xB4	
					+	0x06 0x14 0x00 0x04 0x00 0x34 0x12 0x56 0x01 0xB5	
		Read				0x07 0x14 0x00 0x05 0x00 0x34 0x00 0x00 0x12 0x56 0xB5	
	Sleep Timer				-	0x06 0x14 0x00 0x04 0x00 0x34 0x12 0x57 0x00 0xB5	
					+	0x06 0x14 0x00 0x04 0x00 0x34 0x12 0x57 0x01 0xB6	
		Read				0x07 0x14 0x00 0x05 0x00 0x34 0x00 0x00 0x12 0x57 0xB6	
	Standby Mode	LAN On / LAN Off				ON	0x06 0x14 0x00 0x04 0x00 0x34 0x0C 0x36 0x01 0x8F
					OFF	0x06 0x14 0x00 0x04 0x00 0x34 0x0C 0x36 0x00 0x8E	
		Read			0x07 0x14 0x00 0x05 0x00 0x34 0x00 0x00 0x0C 0x36 0x8F		
Baudrate	9600/19200/38400				9600	0x06 0x14 0x00 0x04 0x00 0x34 0x0C 0x38 0x00 0x90	
					19200	0x06 0x14 0x00 0x04 0x00 0x34 0x0C 0x38 0x01 0x91	
					38400	0x06 0x14 0x00 0x04 0x00 0x34 0x0C 0x38 0x02 0x92	
				Read			0x07 0x14 0x00 0x05 0x00 0x34 0x00 0x00 0x0C 0x38 0x91
Exit					0x02 0x14 0x00 0x04 0x00 0x34 0x02 0x04 0x0A 0x5C		

Main Menu	Sub Menu	Sub Menu 2	Sub Menu 3	Sub Menu 4	Value	RS232 Command
OPTIONS	HDMI Cable		Normal / Long / Short		Normal	0x06 0x14 0x00 0x04 0x00 0x34 0x0C 0x37 0x00 0x8F
					Short	0x06 0x14 0x00 0x04 0x00 0x34 0x0C 0x37 0x01 0x90
					Long	0x06 0x14 0x00 0x04 0x00 0x34 0x0C 0x37 0x02 0x91
				Read	0x07 0x14 0x00 0x05 0x00 0x34 0x00 0x00 0x0C 0x37 0x90	
	Information			Write	0x06 0x14 0x00 0x04 0x00 0x34 0x20 0x01 0x00 0x6D	
	Reset		Yes / No		No	*0x06 0x14 0x00 0x04 0x00 0x34 0x11 0x02 0x00 0x5F 0x06 0x14 0x00 0x04 0x00 0x34 0x11 0x02 0x00 0x5F*

Additional commands (Not in OSD)

Main Menu	Sub Menu	Sub Menu 2	Sub Menu 3	Sub Menu 4	Value	RS232 Command
Power	Turn On					0x06 0x14 0x00 0x04 0x00 0x34 0x11 0x00 0x00 0x5D
	Turn Off					0x06 0x14 0x00 0x04 0x00 0x34 0x11 0x01 0x00 0x5E
Force reset						0x06 0x14 0x00 0x04 0x00 0x34 0x10 0x00 0x00 0x5C

Ceiling Mount Installation

If you wish to use a third party ceiling mount kit, please ensure the screws which are used to attach a mount to the projector meet the following specifications:

- Screw type: M6 x 4



■ Please note that damage resulting from incorrect installation will invalidate the warranty.

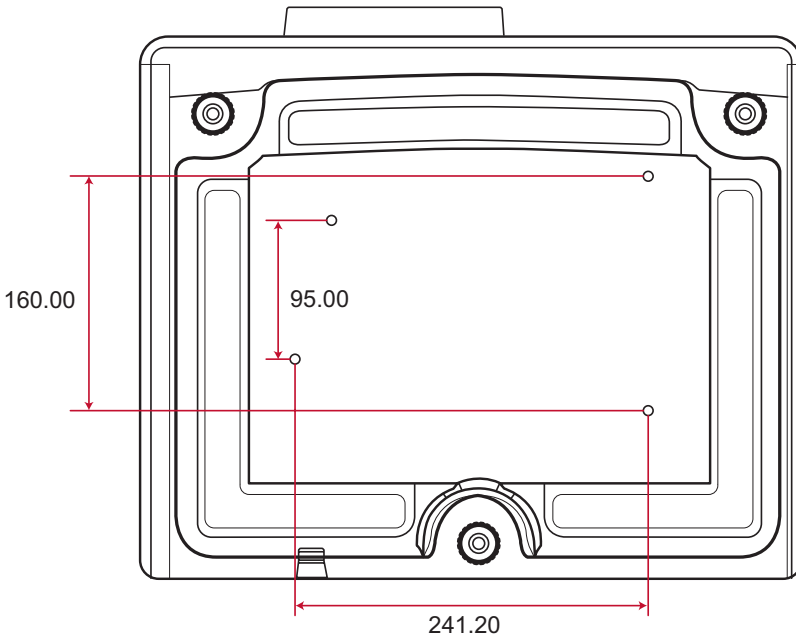
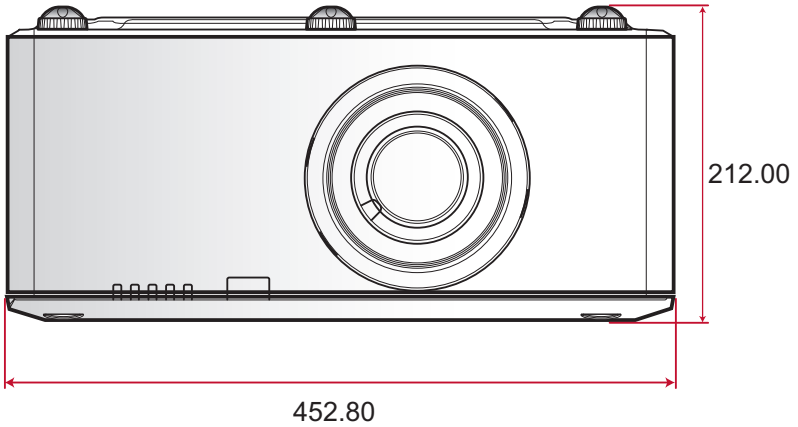

Specifications

Technology	TI 12", Type A DMD, 0.7" XGA, DC3 / 0.65" WXGA, DC3
ASIC	DDP2431 + PW392C
Native Resolution	XGA (1024x768) / WXGA (1280x800) Support Resolution: Up to WUXGA @60Hz (Reduced Blanking) and UXGA @60Hz
Computer compatibility	IBM PC Compatible, support HDTV (1080i/p, 720p, 576i/p, 480i/p) include both PC and component inputs
Video compatibility	NTSC M(3.58MHz), 4.43MHz PAL (B, D, G, H, I, M, N), 4.43MHz SECAM (B, D, G, K, K1, L), 4.25/4.4MHz HDTV 720p (50/60Hz), 1080i/p (50/60Hz), 1080p (24/25/30/50/60Hz) SDTV 480i/p, 576i/p
Horizontal scan rate	15 k - 100 kHz
Vertical scan rate	24-87Hz
Keystone correction	V: +/-20 degrees H: +/-20 degrees (optional warping board)
Weight	Net weight (w/o lens): 13.9 kg Weight with package (w/o lens): 17.3 kg
Dimensions (W x D x H)	453mm(W) x 390mm(D) x 212mm(H) (without lens, with elevators) (17.83"(W) x 15.35"(D) x 8.34"(H))
Power supply	100~240VAC \pm 10%, 50~60Hz (Auto-ranging and Power factor correction)
Power consumption	<ul style="list-style-type: none"> • Normal Brightness mode: 480W +/-10% @ 110VAC • ECO Brightness mode: 370W +/-10% @ 110VAC • Standby mode (LAN off): < 0.5 W
Operating temperature	5°C to +40°C / 41°F~104°F

I/O connectors	<ul style="list-style-type: none"> • Power socket x 1 • HDMI x 1 • VGA In x 1 • VGA Out x 1 • S-Video x 1 • DVI-D x 1 • Video x 1 • Composite x 1 • BNC x 1 • Audio input x 1 • Audio output x 1 • RS232 x 1 • 12V Trigger x 1 • RJ45 x 1 • Wired remote port In x 1
Standard package contents	<ul style="list-style-type: none"> • AC power cord x 1 • VGA cable x 1 • Remote control (with batteries) x 1 • User Manual CD x 1 • Lens mount cover x 1 • Quick Setup Card x 1 • Warranty Card x 1 (China only)

NOTE

- *Design and specifications are subject to change without prior notice.*

Customer Support

For technical support or product service, see the table below or contact your reseller.

Note : You will need the product serial number.

Country/Region	Website	T = Telephone F = FAX	Email
Australia/New Zealand	www.viewsonic.com.au	AUS= 1800 880 818 NZ= 0800 008 822	service@au.viewsonic.com
Canada	www.viewsonic.com	T (Toll-Free)= 1-866-463-4775 T (Toll)= 1-424-233-2533 F= 1-909-468-3757	service.ca@viewsonic.com
Europe	www.viewsoniceurope.com	www.viewsoniceurope.com/uk/support/call-desk/	
Hong Kong	www.hk.viewsonic.com	T= 852 3102 2900	service@hk.viewsonic.com
India	www.in.viewsonic.com	T= 1800 266 0101	service@in.viewsonic.com
Korea	www.kr.viewsonic.com	T= 080 333 2131	service@kr.viewsonic.com
Latin America (Argentina)	www.viewsonic.com/la/	T= 0800-4441185	soporte@viewsonic.com
Latin America (Chile)	www.viewsonic.com/la/	T= 1230-020-7975	soporte@viewsonic.com
Latin America (Columbia)	www.viewsonic.com/la/	T= 01800-9-157235	soporte@viewsonic.com
Latin America (Mexico)	www.viewsonic.com/la/	T= 001-8882328722	soporte@viewsonic.com
Renta y Datos, 29 SUR 721, COL. LA PAZ, 72160 PUEBLA, PUE. Tel: 01.222.891.55.77 CON 10 LINEAS Electroser, Av Reforma No. 403Gx39 y 41, 97000 Mérida, Yucatán. Tel: 01.999.925.19.16 Other places please refer to http://www.viewsonic.com/la/soporte/index.htm#Mexico			
Latin America (Peru)	www.viewsonic.com/la/	T= 0800-54565	soporte@viewsonic.com
Macau	www.hk.viewsonic.com	T= 853 2870 0303	service@hk.viewsonic.com
Middle East	ap.viewsonic.com/me/	Contact your reseller	service@ap.viewsonic.com
Puerto Rico & Virgin Islands	www.viewsonic.com	T= 1-800-688-6688 (English) T= 1-866-379-1304 (Spanish) F= 1-909-468-3757	service.us@viewsonic.com soporte@viewsonic.com
Singapore/Malaysia/Thailand	www.viewsonic.com.sg	T= 65 6461 6044	service@sg.viewsonic.com
South Africa	ap.viewsonic.com/za/	Contact your reseller	service@ap.viewsonic.com
United States	www.viewsonic.com	T (Toll-Free)= 1-800-688-6688 T (Toll)= 1-424-233-2530 F= 1-909-468-3757	service.us@viewsonic.com

Limited Warranty

ViewSonic® Projector

What the warranty covers:

ViewSonic warrants its products to be free from defects in material and workmanship, under normal use, during the warranty period. If a product proves to be defective in material or workmanship during the warranty period, ViewSonic will, at its sole option, repair or replace the product with a like product. Replacement product or parts may include remanufactured or refurbished parts or components.

Limited Three (3) year General Warranty

Subject to the more limited one (1) year warranty set out below, North and South America: Three (3) years warranty for all parts excluding the lamp, three (3) years for labor, and one (1) year for the original lamp from the date of the first consumer purchase.

Other regions or countries: Please check with your local dealer or local ViewSonic office for the warranty information.

Limited One (1) year Heavy Usage Warranty:

Under heavy usage settings, where a projector's use includes more than fourteen (14) hours average daily usage, North and South America: One (1) year warranty for all parts excluding the lamp, one (1) year for labor, and ninety (90) days for the original lamp from the date of the first consumer purchase; Europe: One (1) year warranty for all parts excluding the lamp, one (1) year for labor, and ninety (90) days for the original lamp from the date of the first consumer purchase.

Other regions or countries: Please check with your local dealer or local ViewSonic office for the warranty information.

Lamp warranty subject to terms and conditions, verification and approval. Applies to manufacturer's installed lamp only. All accessory lamps purchased separately are warranted for 90 days.

Who the warranty protects:

This warranty is valid only for the first consumer purchaser.

What the warranty does not cover:

1. Any product on which the serial number has been defaced, modified or removed.
2. Damage, deterioration, failure, or malfunction resulting from:
 - a. Accident, abuse, misuse, neglect, fire, water, lightning, or other acts of nature, improper maintenance, unauthorized product modification, or failure to follow instructions supplied with the product.
 - b. Operation outside of product specifications.
 - c. Operation of the product for other than the normal intended use or not under normal conditions.
 - d. Repair or attempted repair by anyone not authorized by ViewSonic.
 - e. Any damage of the product due to shipment.
 - f. Removal or installation of the product.
 - g. Causes external to the product, such as electric power fluctuations or failure.
 - h. Use of supplies or parts not meeting ViewSonic's specifications.
 - i. Normal wear and tear.
 - j. Any other cause which does not relate to a product defect.
3. Removal, installation, and set-up service charges.

How to get service:

1. For information about receiving service under warranty, contact ViewSonic Customer Support (please refer to “Customer Support” page). You will need to provide your product’s serial number.
2. To obtain warranted service, you will be required to provide (a) the original dated sales slip, (b) your name, (c) your address, (d) a description of the problem, and (e) the serial number of the product.
3. Take or ship the product freight prepaid in the original container to an authorized ViewSonic service center or ViewSonic.
4. For additional information or the name of the nearest ViewSonic service center, contact ViewSonic.

Limitation of implied warranties:

There are no warranties, express or implied, which extend beyond the description contained herein including the implied warranty of merchantability and fitness for a particular purpose.

Exclusion of damages:

ViewSonic’s liability is limited to the cost of repair or replacement of the product. ViewSonic shall not be liable for:

1. Damage to other property caused by any defects in the product, damages based upon inconvenience, loss of use of the product, loss of time, loss of profits, loss of business opportunity, loss of goodwill, interference with business relationships, or other commercial loss, even if advised of the possibility of such damages.
2. Any other damages, whether incidental, consequential or otherwise.
3. Any claim against the customer by any other party.

Effect of local law:

This warranty gives you specific legal rights, and you may also have other rights which vary from local authority. Some local governances do not allow limitations on implied warranties and/or do not allow the exclusion of incidental or consequential damages, so the above limitations and exclusions may not apply to you.

Sales outside the U.S.A. and Canada:

For warranty information and service on ViewSonic products sold outside of the U.S.A. and Canada, contact ViewSonic or your local ViewSonic dealer.

The warranty period for this product in mainland China (Hong Kong, Macao and Taiwan Excluded) is subject to the terms and conditions of the Maintenance Guarantee Card.

For users in Europe and Russia, full details of warranty provided can be found in www.viewsoniceurope.com

under Support/Warranty Information.

Mexico Limited Warranty

ViewSonic® Projector

What the warranty covers:

ViewSonic warrants its products to be free from defects in material and workmanship, under normal use, during the warranty period. If a product proves to be defective in material or workmanship during the warranty period, ViewSonic will, at its sole option, repair or replace the product with a like product. Replacement product or parts may include remanufactured or refurbished parts or components & accessories.

How long the warranty is effective:

3 years for all parts excluding the lamp, 3 years for labor, 1 year for the original lamp from the date of the first consumer purchase.

Lamp warranty subject to terms and conditions, verification and approval. Applies to manufacturer's installed lamp only.

All accessory lamps purchased separately are warranted for 90 days.

Who the warranty protects:

This warranty is valid only for the first consumer purchaser.

What the warranty does not cover:

1. Any product on which the serial number has been defaced, modified or removed.
2. Damage, deterioration or malfunction resulting from:
 - a. Accident, misuse, neglect, fire, water, lightning, or other acts of nature, unauthorized product modification, unauthorized attempted repair, or failure to follow instructions supplied with the product.
 - b. Any damage of the product due to shipment.
 - c. Causes external to the product, such as electrical power fluctuations or failure.
 - d. Use of supplies or parts not meeting ViewSonic's specifications.
 - e. Normal wear and tear.
 - f. Any other cause which does not relate to a product defect.
3. Any product exhibiting a condition commonly known as "image burn-in" which results when a static image is displayed on the product for an extended period of time.
4. Removal, installation, insurance, and set-up service charges.

How to get service:

For information about receiving service under warranty, contact ViewSonic Customer Support (Please refer to the attached Customer Support page). You will need to provide your product's serial number, so please record the product information in the space provided below on your purchase for your future use. Please retain your receipt of proof of purchase to support your warranty claim.

For Your Records

Product Name: _____ Model Number: _____

Document Number: _____ Serial Number: _____

Purchase Date: _____ Extended Warranty Purchase? _____ (Y/N)

If so, what date does warranty expire? _____

1. To obtain warranty service, you will be required to provide (a) the original dated sales slip, (b) your name, (c) your address, (d) a description of the problem, and (e) the serial number of the product.
2. Take or ship the product in the original container packaging to an authorized ViewSonic service center.
3. Round trip transportation costs for in-warranty products will be paid by ViewSonic.

Limitation of implied warranties:

There are no warranties, express or implied, which extend beyond the description contained herein including the implied warranty of merchantability and fitness for a particular purpose.

Exclusion of damages:

ViewSonic's liability is limited to the cost of repair or replacement of the product. ViewSonic shall not be liable for:

1. Damage to other property caused by any defects in the product, damages based upon inconvenience, loss of use of the product, loss of time, loss of profits, loss of business opportunity, loss of goodwill, interference with business relationships, or other commercial loss, even if advised of the possibility of such damages.
2. Any other damages, whether incidental, consequential or otherwise.
3. Any claim against the customer by any other party.
4. Repair or attempted repair by anyone not authorized by ViewSonic.

Contact Information for Sales & Authorized Service (Centro Autorizado de Servicio) within Mexico:	
Name, address, of manufacturer and importers: México, Av. de la Palma #8 Piso 2 Despacho 203, Corporativo Interpalmas, Col. San Fernando Huixquilucan, Estado de México Tel: (55) 3605-1099 http://www.viewsonic.com/la/soporte/index.htm	
NÚMERO GRATIS DE ASISTENCIA TÉCNICA PARA TODO MÉXICO: 001.866.823.2004	
Hermosillo: Distribuciones y Servicios Computacionales SA de CV. Calle Juarez 284 local 2 Col. Bugambilias C.P: 83140 Tel: 01-66-22-14-9005 E-Mail: disc2@hmo.megared.net.mx	Villahermosa: Compumantenimientos Garantizados, S.A. de C.V. AV. GREGORIO MENDEZ #1504 COL. FLORIDA C.P. 86040 Tel: 01 (993) 3 52 00 47 / 3522074 / 3 52 20 09 E-Mail: compumantenimientos@prodigy.net.mx
Puebla, Pue. (Matriz): RENTA Y DATOS, S.A. DE C.V. Domicilio: 29 SUR 721 COL. LA PAZ 72160 PUEBLA, PUE. Tel: 01(52).222.891.55.77 CON 10 LINEAS E-Mail: datos@puebla.megared.net.mx	Veracruz, Ver.: CONEXION Y DESARROLLO, S.A DE C.V. Av. Americas # 419 ENTRE PINZÓN Y ALVARADO Fracc. Reforma C.P. 91919 Tel: 01-22-91-00-31-67 E-Mail: gacosta@qplus.com.mx
Chihuahua Soluciones Globales en Computación C. Magisterio # 3321 Col. Magisterial Chihuahua, Chih. Tel: 4136954 E-Mail: Cefeo@soluglobales.com	Cuernavaca Compusupport de Cuernavaca SA de CV Francisco Leyva # 178 Col. Miguel Hidalgo C.P. 62040, Cuernavaca Morelos Tel: 01 777 3180579 / 01 777 3124014 E-Mail: aquevedo@compusupportcva.com
Distrito Federal: QPLUS, S.A. de C.V. Av. Coyoacán 931 Col. Del Valle 03100, México, D.F. Tel: 01(52)55-50-00-27-35 E-Mail : gacosta@qplus.com.mx	Guadalajara, Jal.: SERVICIRECE, S.A. de C.V. Av. Niños Héroes # 2281 Col. Arcos Sur, Sector Juárez 44170, Guadalajara, Jalisco Tel: 01(52)33-36-15-15-43 E-Mail: mmiranda@servicirece.com
Guerrero Acapulco GS Computación (Grupo Sesiscomp) Progreso #6-A, Colo Centro 39300 Acapulco, Guerrero Tel: 744-48-32627	Monterrey: Global Product Services Mar Caribe # 1987, Esquina con Golfo Pérsico Fracc. Bernardo Reyes, CP 64280 Monterrey N.L. México Tel: 8129-5103 E-Mail: aydeem@gps1.com.mx
MÉRIDA: ELECTROSER Av Reforma No. 403Gx39 y 41 Mérida, Yucatán, México CP97000 Tel: (52) 999-925-1916 E-Mail: rrb@sureste.com	Oaxaca, Oax.: CENTRO DE DISTRIBUCION Y SERVICIO, S.A. de C.V. Murguía # 708 P.A., Col. Centro, 68000, Oaxaca Tel: 01(52)95-15-15-22-22 Fax: 01(52)95-15-13-67-00 E-Mail: gpotai2001@hotmail.com
Tijuana: STD Av Ferrocarril Sonora #3780 L-C Col 20 de Noviembre Tijuana, Mexico	FOR USA SUPPORT: ViewSonic Corporation 381 Brea Canyon Road, Walnut, CA. 91789 USA Tel: 800-688-6688 (English); 866-323-8056 (Spanish); Fax: 1-800-685-7276 E-Mail: http://www.viewsonic.com

Projector Mexico Warranty Term Template In UG

VSC_TEMP_2006



ViewSonic®